

Model radio control CARS

ISSUE No. 1

SIX ISSUES PER ANNUM

Price 50p. \$1.00 (US) DM2.50 Fr.F4.50 Glr.2.50 Sw.Fr.2.50

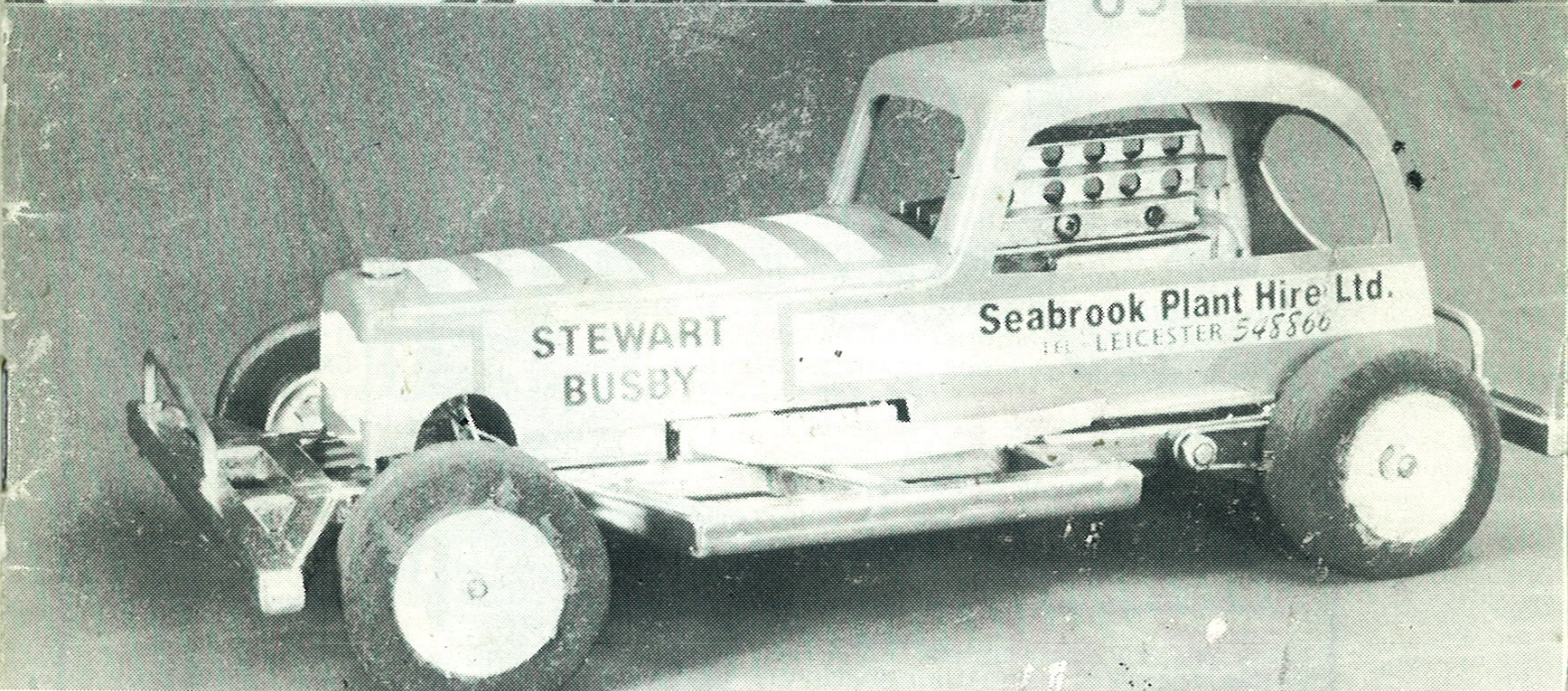
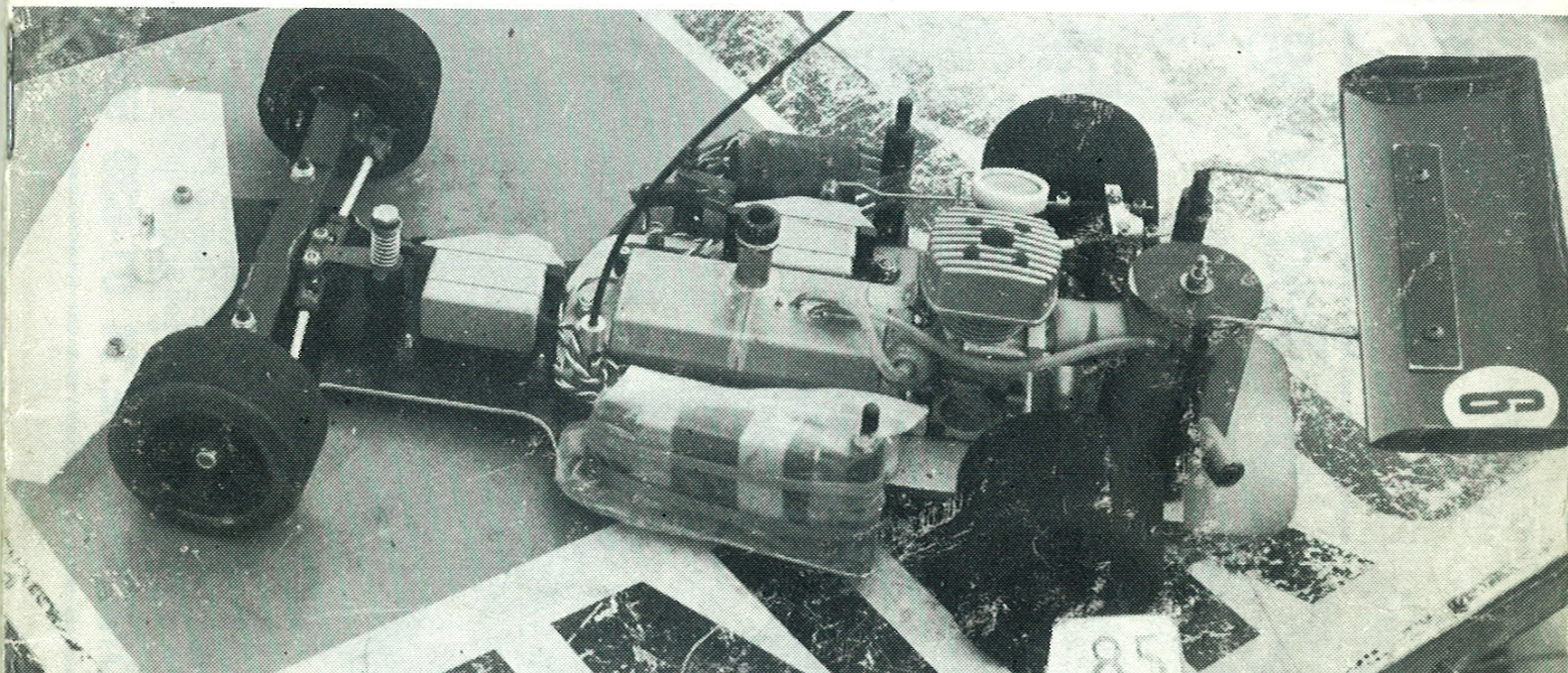

IN THIS ISSUE : CLUB & TRACK REVIEW : WHAT GOES ON AT PB PRODUCTS : BRITISH NATS AT LILFORD PARK : MYSTERIES OF TUNING : MAKING A START WITH R/C MODEL CARS : ELECTRIC CAR ELECTRONICS : "SPRING-HEELED JACK" : GREAT ELECTRIC EXPLOSION : RADIO STOCK CAR ASSOCIATION : BRITISH RADIO CAR ASSOCIATION

1

AS10 05
PROGRAM

SUNDAY
of Derby

westcham / Biggin Hill to right
2 miles past Herton Crossway
1 mile off lights.
turn left to DOWN (love) Village.
cut in ED and out DOWN - To WEST Hill
100 yds
150 yds
150 yds
150 yds
on level
about 2.

R/C CARS

Ted Longshaw for Service & Experience



Shown are just some of the kits and spares in stock at our Biggin Hill showroom. Kits from U.S. including Associated, Delta, H.R.E., Marker and from Italy Euro-Champ SG, from England Mardave and Supercar PB International. Tyres from all manufacturers, plus Ultimara, Parma, etc. Fantastic range of Lexan body shells 1/8 and 1/12 Futaba radios, engines from K. & B., S. Tigre, O.P.S., Veeco, McCoy models, etc., etc. If it's for R/C cars we've probably got it. Interested? Then send 50p for list or visit showroom at Biggin Hill (by appointment only). Office:

80 PEPYS ROAD, LONDON S.E.14 01-639 5080

66 55 313
1968

radio control MODEL CARS

Editor: "Dickie"
Laidlaw-Dickson.

SHOWING THE FLAG . . .

I HAVE always liked to think that radio controlled model car racing first began to be a real organised hobby and sport from the original Easter Meeting at Ashlyns' School, Berkhamsted in 1971. In Jubilee Year when flag waving seems the in-thing I am chasing the personality cult by a picture of myself starting the first race in 1971! Now I am inviting support for a new magazine which will be coming out approximately every two months until such time as support encourages a monthly issue. Since it is only a little venture, a "cottage industry" I am not going into the editorial "we" as it sounds a bit pompous.

What is important about the "we" aspect is the support that is essential if a small mag like this is to get off the ground and stay that way. Trade support has been generous, thank you everybody, and reader interest and potential most encouraging from conversations at meetings this summer. But vital, and life blood of a specialist publication, is enough of the more skilled enthusiasts to contribute articles; of the less expert to write in raising queries on which interest articles can be built; and for all and sundry to keep us posted with events in their parts of the country and continent, for we (it has slipped in!) want to cater for simply everybody anywhere interested in r/c model cars. News from everywhere is welcome. Do not worry if your language is not English - send it along and between us we will produce a result. The same with drawings and sketches - back of the envelope stuff can be redrawn.

This first issue deals in the main with presenting the picture as it is today; with



a lion's share of space devoted to the newcomer who has so far not had much opportunity to enjoy "how-to" articles with very limited written matter on offer. Experts please do not scorn the beginners stuff - everyone starts at the bottom - though surprisingly climbing up can be phenomenally rapid if some of the current successful youngsters are any token!

Please tell us what you want; what you like; what you don't like; we (and this means all of you too!) will in the words of Jeeves "endeavour to give satisfaction."

Cover: Your choice! Fast exciting racing cars or the more robust excitement of the stock car circuit.

NEXT ISSUE: AMERICAN STORY - 1st WORLD CHAMPS IN CALIFORNIA IN WORDS AND PICTURES BY OUR MAN ON THE SPOT PHIL GREENO : PUTTING TOGETHER A STOCKCAR KIT : MORE ON MAKING A START - TYRES, WHEELS, LINKAGES, BODIES : LOOKING AT THE TOPS - PB INTERNATIONAL, ASSOCIATED, SG : CLUB SCENE : LETTER BOX : WINTER ELECTRICS.

Published by L-D EDITORIAL & TECHNICAL SERVICES LTD., P.O. Box 30 HEMEL HEMPSTEAD, HERTS. HP1 1NL.

R/C MODEL CAR TYRES-TYRES-TYRES

SUPER GRIP ————— **FANTASTIC VALUE**

Dia.	Bore	Width	Hard	Med/Hard	Med/Soft	Soft
2¾ in.	1 13/16 in.	1¼ in.	£1.10	£1.30	£0.90	£0.90
3 in.	1 13/16 in.	1¼ in.	£1.20	£1.40	£0.95	£0.95
3¼ in.	1 13/16 in.	2½ in.	£2.45	£2.80	£1.85	£1.85
3 in.	1 13/16 in.	2½ in.	£2.40	£2.75	£1.80	£1.80

All Prices Per Pair. Post Free U.K. Only

***ALL TYRES IN BLACK**

***SPECIAL SIZES CUT TO ORDER**

Ask for Raydio Tyres by name
at your local Model Shop
or direct from

RAYDIO TYRES

(Formerly
Raydio
Bodies)

Tel:
0200-
24913
(Evenings)

35 LITTLEMOOR RD., CLITHEROE, LANCS., ENGLAND

Supplier to the retail trade and car kit manufacturers U.K. and Abroad



THE BRCA was formed in 1972 following a meeting of interested people at the Aubrey Park Hotel in Redbourn, Nr. Hemel Hempstead. Founder members at that meeting included such stalwarts as Keith Plested, Wes Raynor of Mardave, who put down the first purpose built circuit at Newbridge, Ted Longshaw, currently Chairman of EFRA, the European organisation, the Lindstroms who established the Yorkshire based Littlemoor Park track, Dave Rogers, now masterminding electric car racing meetings at Alexandra Palace, . . . to mention but a few. There were many more and apologies at once for not including the names, tell me about it if you have been left out!

It can fairly claim to be the largest European organisation of its kind and a keen member of the fourteen country EFRA (Europäische Federation Radiogesteuerter Automobile) which manages national and international meetings, agrees compatible rules, and *tries* to avoid important date clashing. BRCA publishes a monthly newsheet *Circuit Chatter* which is basically national and international racing news and results, issues an annual handbook with racing and constructional rules, provides insurance company in Great Britain for all member drivers and costs (currently) £3.00 a year to belong.

Below we give list of current officials (write to secretary Tom Martin to join) regional/area representatives, summary of current rules.

ASSOCIATION MEMBERSHIP

All applications for full membership and all general enquiries should be made to the Secretary, 7 The Green, Werrington, Peterborough. PE4 6RT.

All applications for Associated membership (£1.50 per year) and Junior membership for under-16's (£1.50 per year) should be submitted to a Regional Representative for verification.

ASSOCIATION OFFICIALS

Chairman: K. G. Plested, P.B. Products, Downley Road, Havant, Hants. Tel. Havant 71774. Evenings Emsworth 2607.

Secretary: T. H. Martin, 7 The Green, Werrington, Peterborough. PE4 6RT. Telephone (0733) 72114.

REGIONAL COMMITTEE REPRESENTATIVES

London/S.E.: C. E. Longshaw, 80 Pepys Road, New Cross, London. S.E. 14. Telephone 01 639 5080.

London N./H. Clys: D. Rodgers, 18 Cedar Avenue, Enfield, Middx. Telephone 01 804 1183.

East: E. Booker, Kennel Bungalow, Barnwell, Nr. Cundle, Peterborough.
S. Midland: J. Elliott, 8 Jubilee Drive, Glenfield, Leicester. Telephone Leicester 874683.

W. Midland: R. Bates, 101 Vivian Road, Fenton, Stoke-on-Trent, Staffs.

N. Midland: D. Preston, The Spiral, Huntingdon Drive, The Park, Nottingham. Telephone (0602) 46665.

N.W./Scotland: F. Livesey, "Hilbre", 107 Station Road, Delamere, Cheshire. Telephone Sandiway 88 3888.

N. & W. Yorks: P. Pagdin, 100 Calverley Lane, Bramley, Leeds. LS13 1HE. Telephone (0532) 566603.

N.E./E. Yorks: A. Maulson, 1 Scrubwood Lane, Molescroft, Beverley, E. Yorks. Telephone Hull 882329.

EUROPEAN FEDERATION OF RADIO-OPERATED AUTOMOBILES

The B.R.C.A. is an affiliated member of E.F.R.A. Other affiliated countries are Belgium, France, Germany, Italy, Sweden, Switzerland, Spain, Austria, Yugoslavia, Ireland, Holland, Luxemburg and Monaco.

The President of E.F.R.A., elected for 1977, is:

Ted Longshaw,
Beech Tree House,
West Hill,
Downe, Orpington,
Kent.

CONSTRUCTION AND OPERATION RULES
1977

A CAR must be a 1/8th scale (within 10%) replica of an actual racing car in all possible areas OR must be a reasonable representation of a racing car within the given dimensions.

The Race Director may disqualify any car that, in his opinion, would be a hazard to spectators or other cars.

The maximum engine displacement is 0.214 cubic inches (3.5 c.c.).

All cars must have a declutching device.

All cars must have operating brakes capable of stopping the car and holding the car motionless with the engine running.

**The fuel system capacity shall not exceed 4 fluid ounces (7.22 cu. in.).

The minimum dry weight (ready to run, less fuel) is five pounds.

Wheel rim diameter 2 1/8 in. maximum, 1 3/4 in. minimum, or scale.

Wheel nuts and/or axles shall not protrude beyond the wheel.

Bumpers must be constructed so as to minimise injury that may result from being hit by a car.

All cars must be silenced to a level not exceeding 80dB at 30 ft. under operating conditions.

All hardtop cars must have transparent windshields fitted.

Side and/or rear windows, if any, must be transparent or open.

A driver figure consisting of at least a driver's head (arms, shoulders, etc. recommended) shall be mounted in an appropriate position in the car. This figure shall be realistic in appearance, colour and garb. **N.B. Clear plastic figures, drivers with no helmet, orange-haired gremlins, etc., are not realistic.

No portion of chassis, wheels and tyres or equipment (bumpers excepted) may extend beyond the body, except to the rear, except for Formula cars and abbreviated bodies with no engine cover. Openings in the body or cockpit floor, other than those appropriate to full-size cars (scoops, vents, etc.) shall be kept to a minimum. An opening no larger than 3 1/2 in. x 3 1/2 in. for engine access is permitted. Openings for necessary mechanical and electrical components shall provide not more than 1/2 in. clearance around such components.

Continued on page 8.

1977 DIMENSIONS

FORMULA CARS

TYRES — Tread width — 1 in. min. 2 1/2 max.

Minimum diameter — Front 2 1/4 in. Rear 2 1/2 in.

OVERALL WIDTH — 10 1/2 in. max.

BODY WIDTH — 8 1/2 in. max.

BUMPERS — 10 1/2 in. max. width.

WING — 8 1/2 in. max. width.

WING SIDE DAMS — 4 in. long max. 3 in. high max. 1/2 in. max. above wing.

CANARD FIN — 8 1/2 in. max. width.

***The maximum height of the wing trailing edge is 5 1/2 in. and side dams may extend 1/2 in. above this making the maximum height of any part of the aerofoil 6 in.

SPORTS/G.T. CARS

TYRES — Tread width 1 in. min. 2 1/2 max.

Minimum diameter — Front 2 1/4 in. Rear 2 1/2 in.

OVERALL WIDTH — 10 1/2 in. max.

BODY WIDTH — 10 1/2 in. max.

WING — 10 1/2 in. maximum width.

BUMPERS — May extend 1/4 in. beyond side of body or to 10 1/2 in. whichever is less.

WING SIDE DAMS — 4 in. long max. 1 in. high max. 1/2 in. max. above wing. These measurements are for add-on dams only. Otherwise dams must be within 10% of scale.

***The maximum height of the wing trailing edge is 8 in. and side dams may extend 1/2 in. above this making the maximum height of any part 8 1/2 in.

SALOON CARS

TYRES — Tread width 1 in. min. 2 1/2 in. max.

Minimum diameter — Front 2 1/4 in. Rear 2 1/2 in.

OVERALL WIDTH — 10 1/2 in. max.

BODY WIDTH — 10 1/2 in. max.

SPOILERS — 10 1/2 in. max. width. 1 1/2 in. max. chord.

BUMPERS — May extend 1/4 in. beyond side of body or to 10 1/2 in. whichever is less.

***Under 1977 rules spoilers may be fitted direct to the chassis but must conform to all other given dimensions.

***There is no limit on the number of seats fitted in the car modelled.

***Scoops or vents are not permitted in the roof of the car, unless present in the car modelled. Holes for engine access must be immediately above the engine.

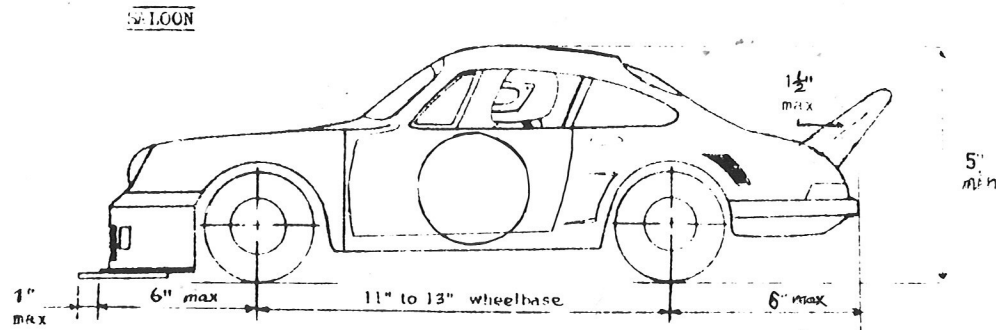
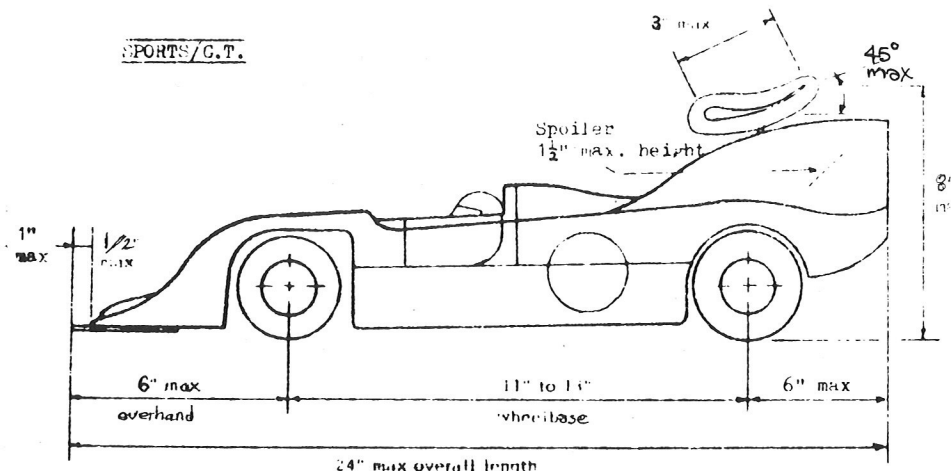
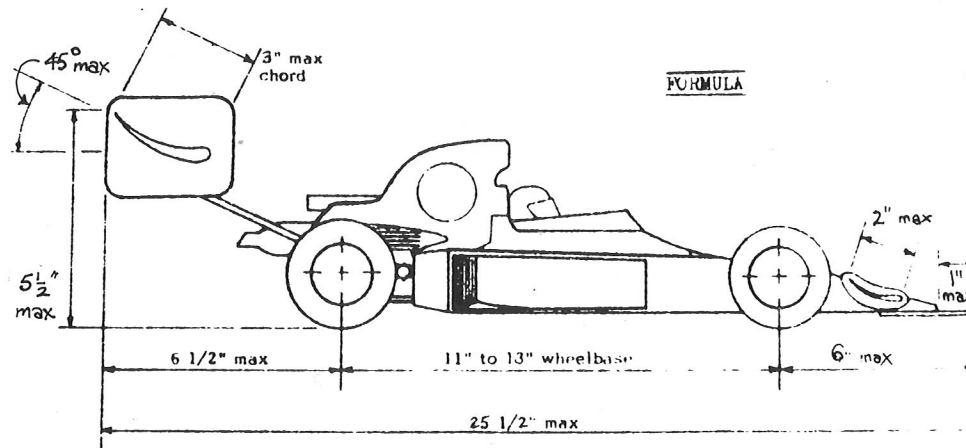

When initially entered in a meet the body must be neatly finished and complete.

The body and chassis must be securely joined at all times when a car is racing.

PROCEDURE AND OPERATING RULES

Every driver entering a B.R.C.A. approved meeting should have proof of Association membership and a current G.P.O. licence to operate radio control equipment.

Radios should have at least two

frequencies available. Where frequencies conflict in finals, the fastest qualifier shall choose, providing it is possible for other drivers to change to the available frequencies.

A Race Director may request inspection of any entrant's car, at any time, to cover any or all applicable specifications.

Any part of a car may be substituted during a race except the chassis. The chassis may be changed with the approval of the Race Director.

Treatment of tyres with additives is prohibited.

**4 fluid ounces 114 c.c.



EFRA — The European organisation to manage radio controlled model car racing in Europe.

President (1977):
TED LONGSHAW
Beech Tree House,
West Hill, Downe,
Orpington, Kent.

NATIONAL ASSOCIATION ADDRESSES

Austria
O.E.F.M.A.V.,
J. Maringer,
Haunspergstrasse 21,
A-5020 Salzburg.

France
F.F.M.A.R.C.,
Rue de Conflans 17,
F-94220 Charenton.

Holland
Nomac,
Franz Leharlaan 26,
NL-1546 Heemstede.

Luxemburg
L. Bausch,
Reckenthal 93,

Sweden
Ing. Rolf Stahre,
Flintbacken 12 Bie,
S-64100 Katrineholm.

Belgium
R. Tassaux,
30 Rue H. Marichal,
B-1050 Bruxelles.

Germany
Horst Griesal,
Wettersteinstr. 18,
D-8931 Untermeitingen.

Italy
P. Capelli,
Via Livrasso 14,
I-26100 Cremona.

Monaco
Aero Club de Monaco,
M.P. Follette Dupuits,
1 Montee Des Revoires.

Switzerland
Leo Jost,
Lindenstr. 46,
CH. 8302-KLOTEN.

Finland
K. Kansakoski,
Vahantuvantie 6 B 21
00390 Helsinki 39,
Suomi.

Great Britain
Mr. T. Martin,
7 The Green,
Werrington,
Peterborough.

Jugoslavia:
AVTO MOTO DRUSTOV,
SLOVENIJA AVTO,
Sekcija RCavtomobilov,
61000 Ljubljana.

Spain
Carlos Merseburger,
Calle Travesara de los
Cortsi 98,
Barcelona 14.

MARDAVE PIONEERS IN R/C CAR RACING

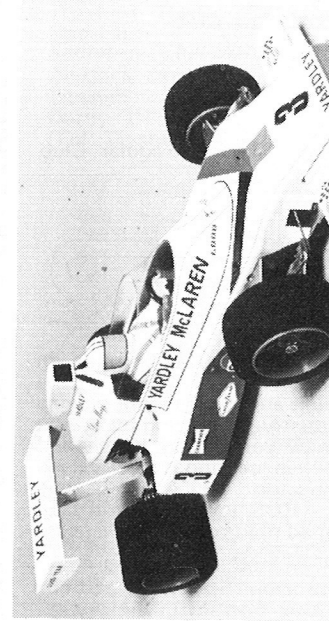

Racing Car Kits McLaren M23 F.1 in 1/4th scale	all £21.50
Hesketh F.1	
Lola T294 Sports	
Silencer for Veco and most engines	£1.95
Racing Car Stock Car	£1.95
Heat Sink	£1.25
Wheels Front, 3/16 in. bore	35p each
Rear, 1/4 in. bore with 50 tooth gear	70p each
Tyres Front, black foam rubber, standard	55p each
Front, black foam rubber, hard	70p each
Rear, black foam rubber, standard	95p each
Flywheel/clutch unit Complete with 13t hardened steel drive gear and 1/4 in. UNF crankshaft adaptor (6mm adaptors are also available)	£3.50
Bodyshells Yardley McLaren F.1 with rear aerofoil Hesketh F.1	£2.50
Capri R. S. Saloon	£2.60
Vauxhall Firenza Saloon	£2.60
Lola T294 with rear aerofoil and fin plate	£2.90
Body Mounting Tray Kits Dural front and centre trays for each of the above bodies	£1.35
Driver 1/4th scale figure	26p
Driver 1/8th scale figure	£1.25
Transfers Giant size sheet, 100 sponsors decals + 35 numbers	12T
NEW ITEMS. Twin needle roller flywheel/clutch unit with pinion, for racing cars only.	£7.00
Air filter for Perry carb.	80p
STOCK CAR KIT	£21.50

Mardave cars are available from all good model shops. In case of difficulty we will be pleased to supply direct

Trade Enquiries to:

MARDAVE R/C RACING
30 Roecliffe Road, Woodhouse Eaves
Loughborough, Leicestershire
Tel: Woodhouse Eaves 890466

Retail Orders to:

MARDAVE R/C RACING
Rookery Lane, Groby, Leics.

0533

Tel: Leics. 879791

Callers welcome Thurs. Evening 7-9 p.m.
Sat. Morning 10-11 p.m. or by appointment.

0509

CLUB & TRACK REVIEW

THE B.R.C.A. caters for the individual member directly and has not as yet extended its organisation to affiliate groups as such. However, the annual programme of events takes notice of their existence and indeed all race meetings are held on one or other of the tracks which clubs have provided. There is no track headquarters, though perhaps the nearest to a r/c model "Brooklands" would be Lilford Park which is the home of the Lilford Park R/C Model Car Club to which BRCA Secretary Tom Martin belongs.

A number of clubs operate on temporary tracks which they lay out on each occasion on ground which at other times is used for something else, such as playgrounds, car parks, hard tennis courts and the like. No comprehensive list has been researched and the notes

that follow are not guaranteed to be right up-to-date, all embracing, or necessarily correct! But it makes a start; we shall be greatly helped if club secretaries send information of their tracks and activities, and correct any information which may not be right.

To those in search of a nearby track we would say that if a suitable nearby club does not appear to be listed they should in the first place contact the Area BRCA representative and seek his help. Then if the field is still open, a letter to the local newspaper inviting interested parties to get in touch, a note to us in the same vein, and a search of the district for a possible track site. It sounds easy but involves a lot of work, so that only the keenest groups get going... once it is off the ground and running then the members come rolling in. So go to it willing horses!

Aldershot Model Club (Car Section)

Secretary: RR. Walter,
32 Legge Crescent,
Aldershot, Hants.
Car Park Circuit. Club race programme.

Beaverlac R/C Car Club

Secretary:
A. Maulson,
1 Scrubwood Lane,
Molescroft,
Beverley.
Permanent Club Circuit. Regular Club and Open Meetings.

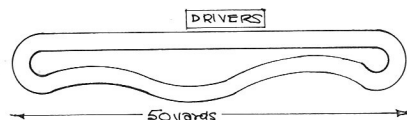

This is CATFOSS, HULL. Lap Length 150 yards, approximately. One of the first tracks built and now showing signs of its age. Industry is creeping up on the area and a new venue may be needed soon. Meanwhile location is near village of Brandesburton on A165. Leave Beverley on A1035, join A165 and take 2nd unclassified road on right on leaving village.

Avon Cosmetics Sports & Social Club (R/C Car Section)

Secretary: N. Crow,

14 Welford Road,
Chapel Brampton,
Northants.

Car Park Circuit. Meetings Sundays and one evening a week. Has now run two "Model Spectaculars" in association with the company.

Leicester R/C Car Club (Mardave Owners' Club)

Secretary: W. Raynor,
30 Roecliffe Road,
Woodhouse Eaves,
Loughborough, Leics.

Permanent club circuit. Full club race programme. Regular Stock Car meetings.

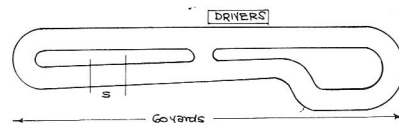

NEWBRIDGE, Leicester. One of the very first built. Lap length approximately 110 yards. On B5380 at the Ratby turn between Kirby Muxloe and Desford. From Leicester take A47 (Hinckley) to Leicester Forest East. After passing over M1 turn right onto B5380. Is main centre for Stock Car events via the Radio Stock Car Association.

Lilford Park R/C Model Car Club

Secretary: Lilford Model Car Club,
Lilford Estate, Oundle,
Peterborough. PE8 5SG.

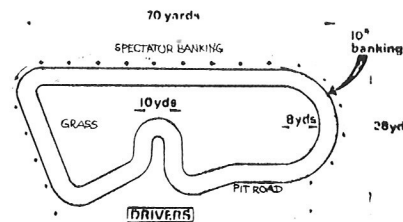

LILFORD PARK, Oundle. Lap length 175 yards. Room to extend to 250 yards. Permanent track, with grass and sand/mud outfield. Good and fast. Good pit facilities under cover. Off A605 Oundle/Thrapston road. In grounds of "stately home" with full catering, picnic, etc. facilities.

Wrexham Model Club (R/C Car Section)

Secretary: Ray Moffat,
4 Ffordd Elfed,
Wrexham. LL12 7LU.

Using old Army Parade Ground, but moving on to permanent track. Some workshop facilities (courtesy comp secretary).

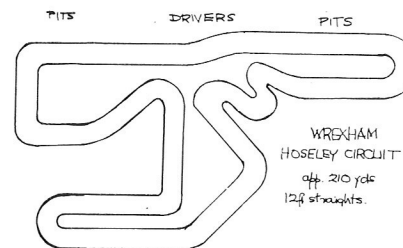

Torbay Radio Auto Club (TRAC)

Phil Pontin,
9 Lucerne, Lower Warberry Road,
Torquay.

Car Park Circuit marked out in local holiday camp.

Surbiton Town Sports Club (R/C STOCK CAR Section)

Secretary: G. Dudman,
1 Chatsworth Gardens,
New Malden,
Surrey.

Permanent Circuit. Club and Open Meetings.

Yorkshire R/C Model Racing Car Club

Secretary: J. Lindstrom,
87 Ashwell Road,
Bradford.

Permanent Circuit. Regular club and open meetings.

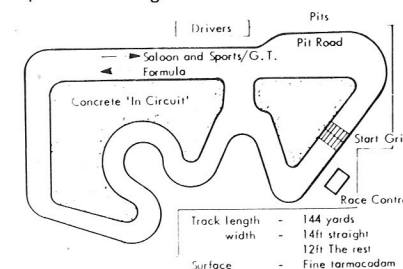

LITTLEMOOR PARK, Bradford. Lap length 144 yards. Interesting layout. Has hosted Nationals. Enterprising programme including Mini Marathon. Surface: Fine Tarmacadam.

Portsmouth R/C Car Racers

Secretary: K. Plested,
3 Woodland Street,
Portsmouth.

Part year hard tennis court use. Regular club practice meetings.

Tibshelf Radio Controlled Racing Car Club

Secretary/Chairman: Ray Heffer
24 Back Lane,
Tibshelf,
Derby. DE5 5LN.
(Tel: Tibshelf 2805)

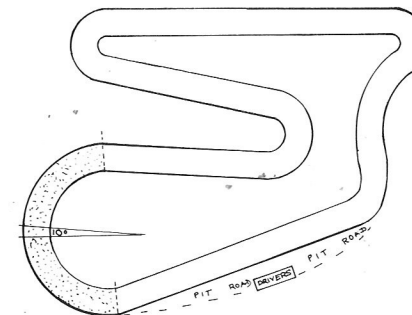

TIBSHELF INTERNATIONAL CIRCUIT

permanent track just completed. Lap length 234 yards. Width 12 ft. Main corner banked 10deg. Only waiting for grass to establish on in field to be ready for some fine meetings.

Lies midway between Matlock and

Mansfield. Village is at the junction of B6036 — B6039 — B6014 and track at the Parish Sports Ground.

Bovingdon Model Car Club:

Secretary: Pat Bligh,
45 Millview Road,
Tring.

(Tel: Tring (8282) 4624.

Track laid out on airfield apron at former U.S. Transport Aerodrome at Bovingdon, Nr. Hemel Hempstead. Good surface. Present lap length about 150 yards, but capable of extension (at present alternative layouts on trial). On road from Hemel Hempstead to Chesham by village of that name.

Nottingham R/C Car Club

Secretary: D. Preston,
The Spiral,
Huntingdon Drive,
Nottingham.

Permanent circuit at Basford. Regular club and Open Meetings.

Stockport R/C Car Club

Secretary: T. P. R. Merica,,
98 Dene Road,
Didsbury,
Manchester.

Car park circuit.

Stoke-on-Trent R/C Car Club

Secretary: J. P. Leigh,
76 Little Cliffe Road,
Fenton,
Stoke-on-Trent.

Large car park circuit. Regular club practice meetings.

Woodspring Radio Auto Club

Secretary: R. Beckett, G.B. Models
(Ref. M/C),
9 Thornbury Road,
Uphill,
Weston-S-Mare.
Avon.

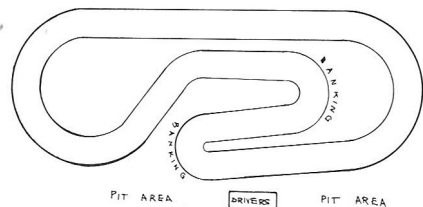

Mendip Model Motor Racing Circuit — a splendid permanent circuit now under construction (September 15th completion the aim) at Bleadon, about 200 yards off A370 Weston-S-Mare/Bridgwater Road. About 1/2 mile from the sea. Hope to host a meeting

here during Pontins Model Week at their Brean Sands Holiday Camp. Lap length 225 yards. 15 ft. width main straights and bends, rest 12 ft. Banked hairpins.

Tubary Common R/C Car Club

Secretary: H. W. Vear,
J & H. Models,
1288 Wimborne Road,
Northbourne,
Bournemouth.

TUBARY COMMON Circuit is situated on a former six-a-side football ground, with good tarmac surface, under an arrangement with the local authority. Club has been going several months and members find surface excellent in all weathers. Lap length approximately 165 yards. Layout on general conformation of Lilford Park, but dog leg is more angled.

Southern Radio-Car Club

Secretary: Peter Wooldridge,
6 Patricia Avenue,
Worthing,
West Sussex. BN12 4NE.

Stock Car group. New members sought (SAE from enquirers). Negotiating for site to lay permanent circuit.

Canterbury R/C Model Car Club

Secretary: Bernard J. Elsey,
41 Merchants Way,
Canterbury.

Have use at week-ends of local trader's forecourt.

New Circuit and Club Prospects in Notts.

Land already available to build circuit in Notts. Interested would-be members contact Steve Mellors, Church Farm, Cotgrove, Notts. (Tel: Nottm. 892768) or Dave Beatty, 46 Mensing Avenue, Cotgrove.

Gloucester/Stroud Area

Secretary: Ron Major,
Highcroft,
Gunhouse Lane,
Stroud,
Glos.

Would like to hear from interested people for formation of a new club in Gloucester/Stroud area.

PHIL GREENO

MODELS LIMITED

9 Village Way East, Rayners Lane, Harrow, Middx. Tel. 01-8667770

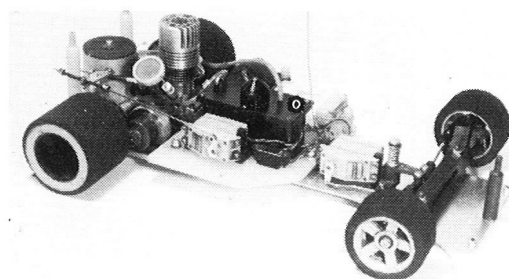

R.C. CARS £ p

P.B. International	75.00
P.B. Expert Comp	56.21
P.B. Expert STD	40.23
P.B. Dual	29.18
S.G. Comp	54.25
Associated RC100	89.95
Associated RC1	59.90
Associated RC2	34.95
Mardave Formula	21.50
Mardave Saloon	21.50
Mardave Stock car	21.50
Ke'jon Stock car	29.50

PLUS A large stock of R.C. car spares always in stock including P.B. Associated, S.G., etc.

All prices correct at time of going to press but subject to alteration.

R.C. ENGINES

Just arrived:

Super Tigre X21 ABC car	40.87
Veco 19 inc sil	24.50
HB 20 inc sil	24.50
Super Tigre 19 ABC car	36.50
K & B 21	47.50
OS 20 inc sil	19.19
ALSO Veco/McCoy conversion parts, including chrome piston/liner assembly, stoker crank-shafts, and High comp heads, etc. Send S.A.E. for price list.	

TUNE UP ACCESSORIES

SILENCERS	£ p
Semco Car	6.95
Semco Car (adapter Veco 19)	1.95
Preston Car Sil	7.95
S.G. Car Sil	7.50

TANKS	
PB Quick Fill (4 oz.)	2.12
Johnson Metal Tank Kit	1.95
Johnson Chicken Hopper Comp	11.55
New GP Racing Tank (Sumped)	7.50

PB RACING HEADS	7.50
Veco/McCoy	7.50
ST 19	7.50
ST 21	7.50
PB Piston Slide Carb 3/8th in. or 7/16th in. Spigot	14.00
Perry 40 Carb.	6.95
Perry 61 Carb.	6.95
HB 20/Veco 19 Heat Sink Head	4.50
PB Heat Sink only	1.95
New GP Slide Carb for K & B 21, OPS 21, ST X21	16.50

New P.B. Expert International kit.

New P.B. International took 1st in Formula One, 1st in Sports, Lilford European Easter Meetings. Kit price £75.00

RADIO

Futaba medium 2 FD 22m servos	63.50
Futaba medallion 2 'brick'	60.00
Futaba twinstick 2 FD 17m servos (dry)	83.00
Futaba steerwheel '2' FD 17m servos (dry)	83.00
Sanwa mini 2 drycell	54.95
Sanwa standard 2 drycell	79.95
MacGregor 2 drycell	52.50
Futaba FD 17m servo (waterproof)	18.50
Nicad conversion for above always in stock.	

PLUS Full range of Futaba, MacGregor, Sanwa and Skyleader Radio.

ACCESS! BARCLAYCARD! HOBBYCARD! H.P. TERMS PLUS FAST MAIL ORDER.

Lectricar with proportional speed control, Porsche or Escort, £44.87.

Also large stock of BO-LINK, JOMAC, JEROBEE, ELECTRO CRAFT 1/12th ELECTRIC CAR KITS AND ACCESSORIES.

specialists in SKYLEADER FUTABA SANWA MacGREGOR

Opening hours: Mon., Tues., Thurs. 9.30-6.00 Fri., Sat. 9-7.00. Closed all day Wed.



RADIO STOCK CAR ASSOCIATION

Stock car meeting in Holland (their rules permit outside rollover bars).

A FAST expanding r/c car section is that governed by the Radio Stock Car Association which has formulated rules, very much on the lines of full size Stock Car Racing as to design and construction, and with special attention to a limited cost formula. This limit, plus the robust nature of the stock car formula, plus the simpler nature of track requirements, means that a much larger pool of potential enthusiasts exists. The teenager still enjoying the novelty of his first wage packets and the young married man following his hobby on a budget can meet on level pocket terms with only individual skills between them.

Another stock car benefit is that the increased ground clearance enables a driver to practice on any reasonably level site, including the lawn at home, assuming he is also complying with silencer regulations of not more than 80dB at 30 ft. — or rather less than the average small garden motor mower.

The track requirements are essentially simple. There should be an outer oval of "fencing" boards about 6 in. high to contain the cars which bounce off them on contact. Inner fence need only be of 2 in. x 1 in. strip laid flat on the ground. Sections can be a few feet long only, joined together with hooks and eyes or other type of snap fastener; outer fence of course will have small supporting feet,

either attached or easily removable. The whole set-up for a track should go in the back of a fair sized estate car or small van. How elaborate it is up to the club; inner fence can be painted up brightly, outer fence either plain or white or could be enlivened with decals. Size depends very much on space available. If we consider a full size lap length going round, for example a football pitch, we arrive at about 400 yards per lap. Model cars are one-eighth scale, so track can scale down to a mere 50 yards circuit as a minimum, with an oval up to twice this length as ideal.

Too big a circuit tends to spoil the fun with not enough cars in close proximity most of the time. If we consider six car events then a 50 yard lap allows an eight yard interval if all spaced out evenly, which is not what participants and spectators really want to see.

Interest has spread quickly to a number of countries in Europe, with Holland leading the way in numbers and enthusiasm, Sweden coming into the picture too, with promises of spiked tyres and ice events in the long winter months (we have yet to see this!)

THE CARS . . .

At the moment two manufacturers head the market, notably Mardave, who were first in the field, and to whom most of the initial work in forming the

association and devising the models must be credited; then there is Ke'jon who make a very similar car (naturally enough within a quite close formula!) and finally there is the Puma, which again follows the nearly standard pattern.

Cars are offered with a square section steel frame chassis already spot welded, to which components must be added, including nerf bars (to fend off the opposition!) rear springing — a sprung axle at the rear and a belt drive from the engine is a special stockcar feature — and the usual steering gear, wheels and so on. Normal clutch common to all r/c cars is used but brakes are not fitted. A one-piece moulded body is included, which will have to be finished, windows cut out, painted, and decorated.

Beginners might get the idea from looking at the kits that it is all too easy and that they can get some square section steel in the same size and weld it up in no time. But take care! Unless you already have some experience of this work it is quite a problem and most of the "homemade" chassis we have seen looked terrible and performed that way.

In our next issue we will be taking readers through the building of a typical stock car and getting it running. Meanwhile, we offer details of the Radio Stock Car Association's Construction Rules and Procedure. For those who seek more knowledge direct then drop a line to Tony Whitehorn, 11 Lime Grove, Blaby, Leicester who is the secretary; or to treasurer Dave Wragg, 1 Bignal Drive, Leicester Forest East, Leicester. Main racing centre at the moment is Newbridge, Nr. Leicester.

Mardave stock car, ready to go when body fitted. It may never be so clean again!

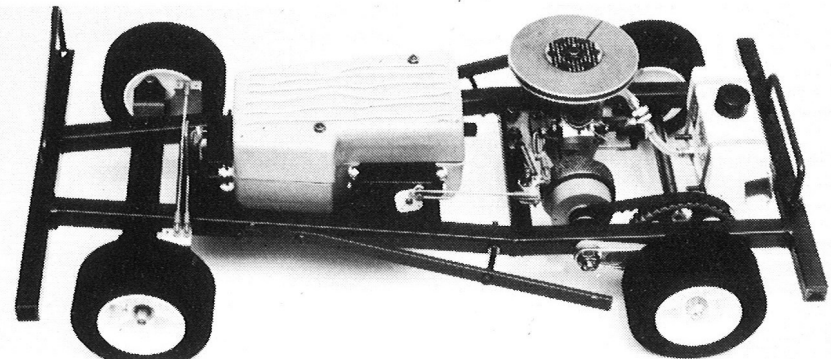

CONSTRUCTION RULES

- (1) **Scale:** Models are to be 1/8 scale and a reasonable representation of an actual full size Stock Car.
- (2) **Length:** Overall length to be within 16 3/4 in. — 17 3/4 in.
- (3) **Width:** Overall width to be a maximum of 9 in.
- (4) **Wheelbase:** To be kept within a minimum of 11 1/2 in. and a maximum of 12 1/2 in.
- (5) **Bumpers:** Front and rear bumpers **must** be fitted with a contact surface of 1/2 in. — 3/4 in. and shall not project beyond the outer edge of the wheels. Centre line of the bumpers to the ground to be 1 3/4 in. — 2 1/4 in. All bumpers and nerf bars must be plugged and have no sharp edges.
- (6) **Overriders:** These **must** be fitted to both the front and rear bumpers. Front to be 1 in. — 1 1/4 in. high from the top of the bumper. Rear to be a maximum of 1 in. from the top of the bumper.
- (7) **Nerf Bars:** These may be fitted to the chassis sides but **must** be on the same level as the bumpers and have a maximum contact surface of 1/2 in. but must not project beyond the outer edge of the wheels.
- (8) **Tyres:** Width 1 1/4 in. maximum. Diameter 2 3/4 in. minimum. 3 1/4 in. maximum.
- (9) **Engine:** The maximum engine size permitted is 3.55cc or 0.214 cu. in. If more than one engine is used the total capacity must not exceed this limit.
- (10) **Fuel Tank:** Size unlimited.
- (11) **Silencer:** The engine **must** be effectively silenced to the satisfaction of the Race Organiser and be a maximum of 80 D.B. at 10 metres.



Some of the RSCA officials enjoy a break at Sandown Park racecourse meeting.

(12) **Body:** The height of the body is limited to 4 ft. — 5 in. measured from the top of the chassis.

(13) **Driver's Name:** This *must* be on the outside of the car.

(14) **Numbers:** All members' official association number *must* be shown on a 1 in. high fin type number plate mounted on the car's roof facing sideways. The numbers are to be black and 3/4 in. high on a white background.

(15) **Grading:** Roofs *must* be painted in the drivers grade classification colour:

'A' Grade	RED
'B' Grade	BLUE
'C' Grade	YELLOW
'D' Grade	WHITE

All new members *must* paint their roof white.

in a MAIN FINAL will be up-graded one grade. Any driver finishing 1st or 2nd A WHITE grade driver winning 3 consolations will be up-graded to YELLOW. grade.

Roof grading must be painted down to the waistline of the body.

(16) **Roll Bars:** Exterior roll bars are *not* permitted for racing.

(17) **Aerofoils:** These may be fitted to a car but may not be more than 10 sq. ins. in area.

The width may not exceed 5 in.

COST RULES

Engine: The cost of the engine and carburettor must not exceed £35 at retail prices, including V.A.T. current on 21st November, 1976. The only modifications permitted are those which can be carried out using hand tools, i.e., filing out exhaust ports.

Car: The cost of the car complete and ready to run, including body, heatsink and silencer, but excluding engine and radio equipment, must not exceed £30 at retail prices, including V.A.T. current on 21st November, 1976.

In the case of scratch built cars the entrant must be prepared to produce replicas of the car, if so requested, for a price of not more than £30.

In the case of modified kit cars alternative modified parts may be fitted and the cost of the original standard part may be deducted from the total which must not exceed £30.

The entrant must be prepared to produce replica modified parts, if so requested unless they are commercial items currently available.

Procedure and Operating Rules: Every driver entering a R.S.C.A. approved meeting shall have proof of Association membership and a current G.P.O. licence to operate radio control equipment.

Radios should have at least two frequencies available. Where frequencies conflict in finals, the fastest qualifier shall choose, providing it is possible for the other driver(s) to change to available frequencies.

The Race Organiser may request inspection of any entrant's car at any time to cover any or all applicable car specifications.

Any part of a car may be substituted during a meeting except the chassis.

Mardave with the lid on! Note good access to motor to reduce lifting off body to make adjustments.

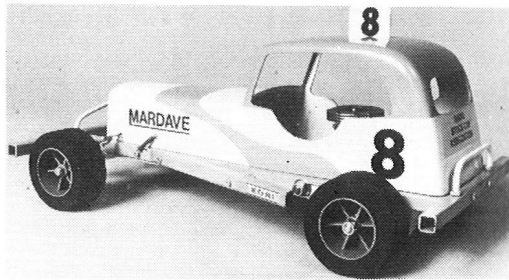

PB PRODUCTS

'Expert' SERIES

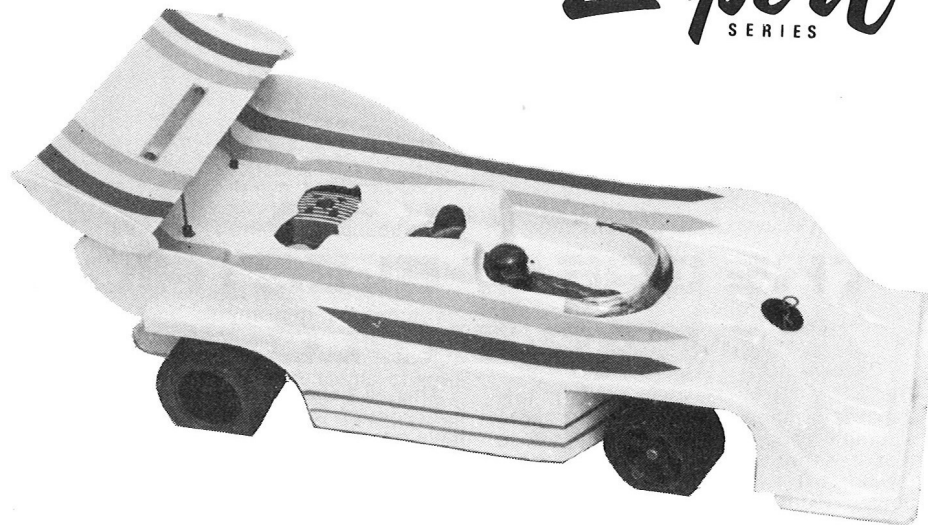

PB INTERNATIONAL KIT is the Experts' Choice. EVERY MAJOR EVENT in the BRCA 1977 RACING CALENDAR to date has been won with a PB INTERNATIONAL Car.

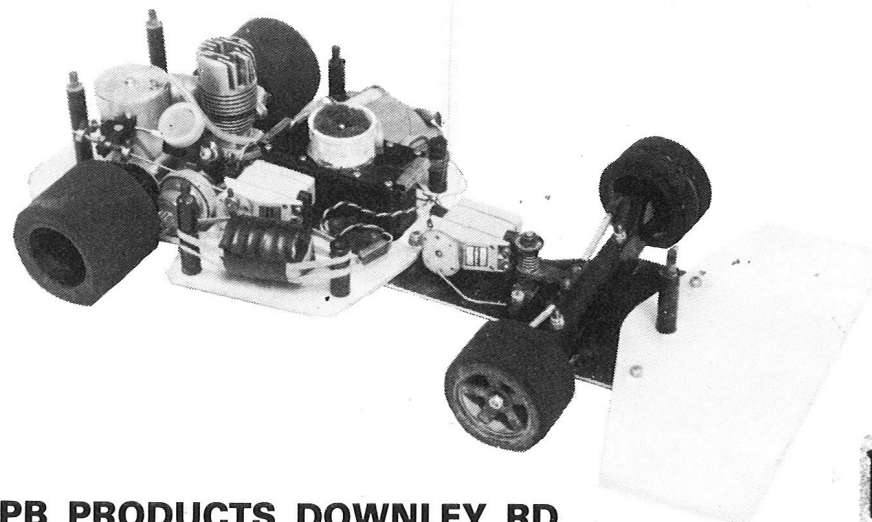

**PB PRODUCTS DOWNLEY RD
HAVANT HANTS**

Tel. HAVANT 71774



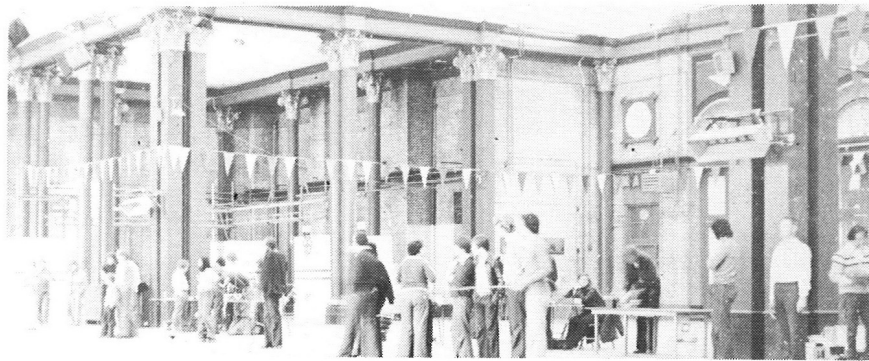

THE GREAT ELECTRIC CAR EXPLOSION

DECLINE OF slot-car racing left Japanese manufacturers with a considerable capacity and little market so that it is not surprising their thoughts turned elsewhere. Free flight electric powered aircraft came along which was a great help, and then suddenly there appeared on the British market the Cyclone and Bullet electric motors, direct descendants of the slot car specials. The same motors have appeared all over the modelling world under a variety of "badge names" but are very much the same thing. In U.S.A. they were seized upon eagerly as power units for a new generation of free-running electric powered r/c controlled model cars — the long sought ideal was here at last!

This all happened several years ago, long enough for our American friends to have got commercially organised and to have formulated appropriate classes in their racing associations. It only hit the British market a few months ago with the advent of the Lectricar. This is (apart from the Japanese motor!) a strictly British enterprise that has been enjoying a startling and well-merited success.

But what is this electric r/c model car racing? We nearly all have encountered the simple single channelled little 1/16th scale cars that have a left oriented turn and come complete with transmitter at what is today's pocket-money price. These are great fun but obviously of limited interest to the "enthusiast" operator. The standard car on offer as a

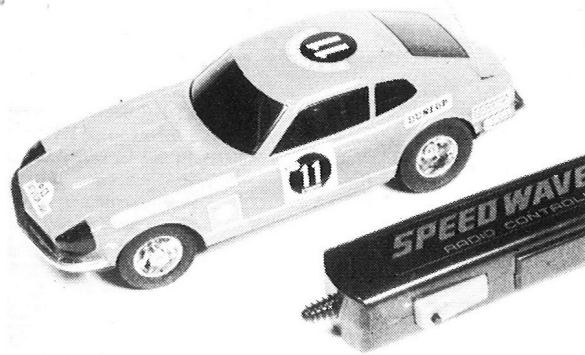

Faded splendour of Alexandra Palace Palm Court.

Tx and Rx in 1/16th scale electric — fun for a start!

Prototype 'Mardave' electric with Brabham body.

kit uses the smaller Cyclone motor powered by six rechargeable nicads producing a total of 7.2 volts. Speed control is by microswitches that provide three forward and three reverse speeds operated by servo; a second servo takes care of the steering.

The kit itself is offered as a simple assembly project, and is indeed just this. Full marks for a beautifully prepared box of parts where everything really fits billing. Scale is one-twelfth with choice at the moment of two bodies from the manufacturers — Ford Escort or Porsche. These are simple ABS plastics which require windows to be cut out and a paint job done but are adequate for the job.

Steering has an adequate failsafe servo saver; a neat plastic radio box is provided and servos can be mounted with double-sided tape without much fear of motor vibration from the electrics doing them any harm. A single charge of the motor will provide up to ten minutes running time. This is achieved via the charging leads provided which can be clipped onto the terminals of the family car battery to provide the current. Maximum length of charge should not exceed twenty minutes which gives approximately half that time running. More usually users will acquire their own 12-volt battery/accumulator which may be any reasonably portable type. Trend is towards the lighter weight motor cycle battery of which the excellent Varley 12. 7/10 20 hour is a good example. Less expensive and less powerful is the WB 12/T5 but adequate for electric recharging (whether it is man enough to run a starter for i.c. powered cars has yet to be discovered). When buying a battery be sure to get it filled with acid — often they are described as

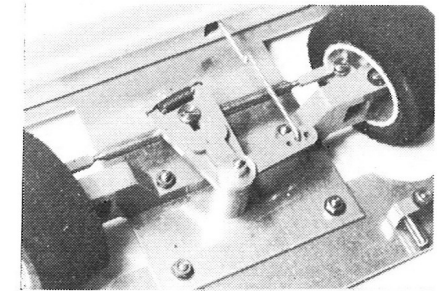

Above and below: Lectricar treatment of front and rear ends. Below that: Mardave steering and failsafe.

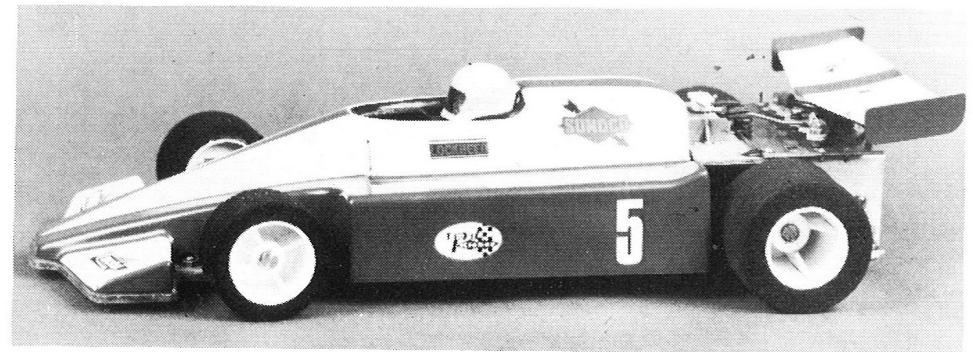
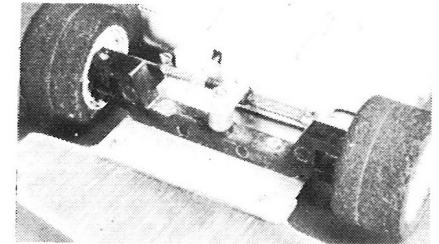
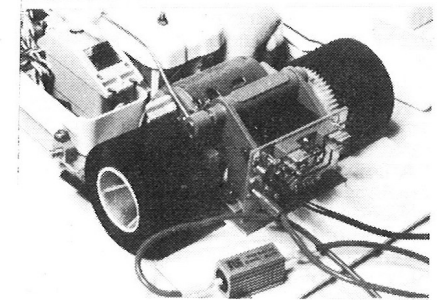

"dry charged" which means what it says. Acid is cheap but regulations on sale make it impossible to buy a bottle to take away.

Meanwhile, in this country at least one other manufacturer, Mardave, is tooling up and should be releasing their variety of electric car as this appears. Indeed, only full order books for their 1/8th scale racing and stockcar kits have kept them back until now. Wes Rayner of Mardave is following a very different line by miniaturising to 1/12 scale the standard 1/8th scale layout, with the batteries (six nicad cells) slung outboard, where in fullsize GP racing cars it is customary to locate the petrol tanks. In addition the Mardave car will operate with proportional speed control rather than the microswitch sequence, which should make for much smoother running and absence of twitchiness. Propo. speed control is obviously the way to do it, though initial cost and the heat engendered, provide problems for the manufacturer.

A limited number of American made cars and kits are coming in; adverse exchange rates make them fairly expensive, but there is no doubt of their quality and the advantage they have enjoyed of being on the market now for some time. A good variety of tyres in a range of hardnesses, specifically for indoor or outdoor use is most valuable.

boLink version of electrics with "street" Porsche body. Indoor and outdoor tyres available.

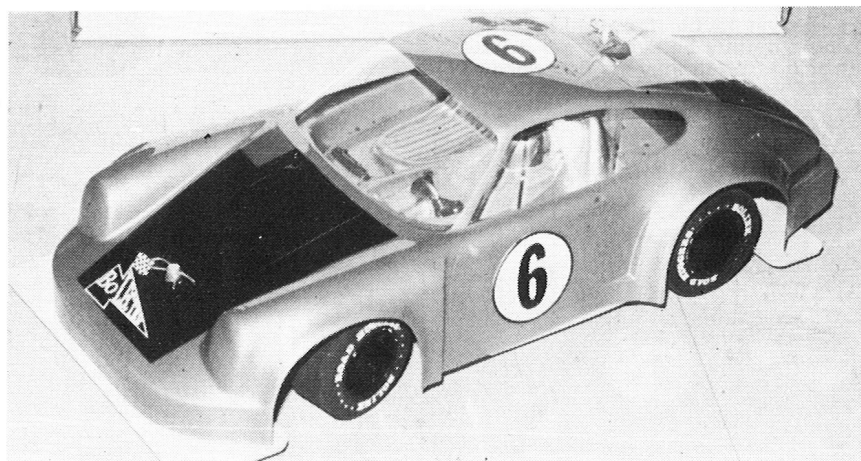

A complete ready to run car with "street" Porsche body and driver is available. Other options include receiver-servo "bricks" which are installed and require only a transmitter to get moving, that is motor/receiver/servos/control are in the one unit. Then a version of this offers a "power train" which gives chassis, motor, speed control, axles, steering as a package. Wheels, servos, radio, body are extra. Quite a wide range of 1/12th scale bodies in clear Lexan are on the market. These have also been prepared for the smaller 1/12th scale i.c. range popular in U.S.A. and so is more extensive than could, at present, be expected from an electric car market alone.

Where can electric cars be run? Virtually any drill hall, church hall, gymnasium, or even a decent sized patio at home can be used. There is no oily deposit, no smell, and a very low noise factor so that a meeting should be welcomed by even the most prickly Vicar or school caretaker. A number of very successful free-for-all evenings have been held already in the Palm Court of Alexandria Palace, in North London. This hall is used normally for roller skating and tends to be highly polished — not ideal for the cars — but the management have been co-operative in cleaning it down to improve road-holding.

Reasonable limit for an evening's racing is thirty-two cars. This allows for the usual six frequencies to be employed plus two split frequencies, to give eight cars to a race. A five minute race

allows some practice lappery in the ten minutes full charge. As each entrant completes his race he can then put his name and frequency colour down for the next free slot (rather like club tennis!) With luck everyone can get in a minimum of three runs an evening, or perhaps a little more over a three-hour period. A small fee is charged to drivers to cover hall hire.

With the present microswitch cars only minimal marshalling is needed as cars can reverse away from hazards — usually wheelbarrow tyres at the corners. Circuit layout is established with simple stick down adhesive plastic tapes, or can be chalked on. A decent long straight plus two or three dog legs to establish changes of lock can soon total up to an interesting lap length of a hundred yards in quite modestly sized halls. Drives should stand a little off the ground — beer (or even milk) crates are ideal for this.

So far racing has taken place under the auspices of the British Radio Car Association who have provided organisation and lap scoring facilities in London (notably Messrs. Dave Rogers, Brian Field, Ellis) and arranged Ally Pally

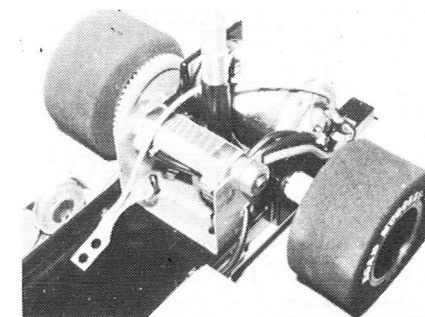

BoLink (USA) use variable rheostat to control speed. Motor is "our" Cyclone under badge name!

hire. Regulations have been minimal; only that motor is Cyclone (or identical "badge" named motor) and nicads do not exceed six in number, i.e., nominal 7.2 v.) Division into GP and GT classes may become desirable when other car choices more generally available. We look to hear of many more electric car meetings throughout the country during the coming darker evenings.

I & D ELECTRONIC CO'S "SMOOTH-TRONIC"

Electric Car Speed Controller with Proportional Throttle and Proportional Dynamic Braking

- VERY WIDE RANGE OF ENGINE SPEEDS** — for precise control over all manoeuvres (e.g., smooth handling through corners).
- FULLY PROPORTIONAL DYNAMIC BRAKING** — giving a smooth transition from full power, down through "neutral" to maximum braking.
- PLUGS DIRECTLY INTO RECEIVER** (positive 1 m/s-2 m/s) — for elimination of servo, push rods, complicated wiring, unreliable switches and hot resistors.
- PERSONALISING ADJUSTMENT** — The position of the TX stick at full throttle, neutral and braking is pre-set by 2 small adjustments.
- SMALL SIZE** — (1.6 x 2.4 x 0.9 in.) — for quick and easy installation.
- LIGHTWEIGHT** (2 oz.) — for maximum acceleration.
- HIGH POWER CAPACITY** — for 7.2 volts, 12 amps (25 amps peak).
- ONLY 0.2 VOLT DROP AT FULL POWER** — ensuring no reduction in performance in acceleration and top speed.
- LOW POWER CONSUMPTION** — for very cool running, and more power available at the wheels towards the end of the race.

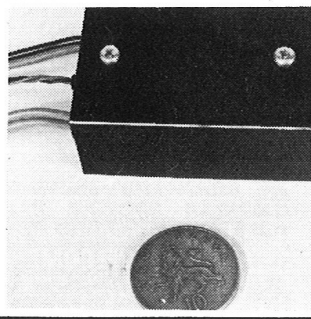

**PRICE: £19.50, inclusive
(£20.50, overseas)**

Send cheque or postal order to:

I & D ELECTRONIC CO.
46 Church Road
Barnes, London SW13
England

Trade enquiries welcomed

OPENING SOON!! Mendip Model Motor Racing Circuit

Bleadon Nr. Weston-S-Mare

The First Purpose Built Model Car
Track in the South-West
220 yards. Asphalt Surface.

Operated by:-

WOODSPRING RADIO AUTO CLUB

Membership Details from:

G.B. MODELS (Ref M/C)

Temporary Membership available for
Holidaymakers

GB MODELS

9 Thornbury Road, Uphill
Weston-S-Mare, Avon
Tel: W.S.M. 26265 (p.m.)

'G.B.' R/C Car Kit Ballraced **£38.07**
Porsche, Surtees, Lola or Indy Body

'P.B.' Expert Series Kits
Plain Bearing **£45** B/Raced **£60**
New International Kit **£75**

Full range of PB parts available
Parts for Scratch Builders
F/Susp assembly **£3.24** Ballraced R/End **£6.65**
Chassis Plate **£2.20** Fuel Tank Kit with Q/F Spout **£1.10**
S.A.E. for full list

ACCESS
Phone in for delivery by return

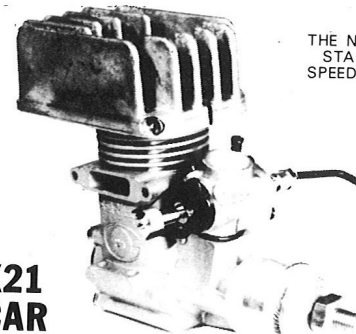

THE NAME THAT
STANDS FOR
SPEED & POWER

SUPER Tigre

**X21
CAR
£40.87 (inc VAT)**

Large stock of spare parts held at Watford for
both Super Tigre and SG Racing Cars. We
are the official outlet for Sabbatinis cars in the
U.K.

Since its arrival last year the Super Tigre X21 has been the pacesetter for other manufacturers to follow. A rugged construction able to cope with the arduous conditions of competitive car racing. Just compare the specification with the opposition. An ABC piston assembly with light-weight piston, bronze bushed bigend conrod, heavy duty 12mm dia. crankshaft running in double ball bearings, specially diecast crankcase not a conversion from aircraft motor, large bore carburettor with the superb idling of all MAG series carburettors, deep finned heat sink, squish band head. BHP .75 at 25,000 rpm, weight 9¼ oz. Used by most of Europe's leading drivers.



SUPER TIGRE MOTORS ARE AVAILABLE FROM THE VERY BEST MODEL SHOPS
WORLD ENGINES

LIMITED

97 Tudor Avenue, Watford, Herts. Phone Watford 42859

Visitors by Appointment

S.A.E. with enquiries please



MODEL CRAFT

5 CROSS STREET, BLABY, LEICESTER.
Telephone Leicester 771397

MARDAVE R/C CARS

McLaren M23 F1	£21.50
Hesketh F1	£21.50
Lola T294 Sports	£21.50
Capri R.S. Saloon	£21.50
Firenza Saloon	£21.50
Stock Car Kits	£21.50

MARDAVE SPARES Mk 4 RACING CAR

CHASSIS Drilled flat dural plate	£2.50
Rear axle bracket	£0.65
Strap	£0.20
Brake unit	£0.30
ENGINE MOUNTS Set of 4 with screws and key	£0.85
SERVO SAVER (steering bellcrank) complete	£0.60
FRONT SUSPENSION Complete	£2.50
King pins	each £0.10
Coil springs	each £0.10
Axle, with nylon block	each £0.20
3/16 in. nyloc nut	each £0.05
FLYWHEEL CLUTCH UNIT Complete	£3.50
13t hardened steel gear	each £0.60
Bush for gear	each £0.20
Cork lining	each £0.06

Clutch drum complete with gear and cork lining	£1.40
Crankshaft adaptor (¼ in. UNF 6mm or 5mm)	£0.25
REAR AXLE	£0.50
Bearing	each £0.15
Bearing lock nut	each £0.07
¼ in. Nyloc nut	each £0.05
WHEELS Front	each £0.35
Rear (with integral drive gear)	each £0.70
TYRES Front, standard rubber	each £0.55
Rear standard rubber	each £0.95

RADIO CRATE	£1.20
FUEL TANK	£0.55
FUEL TANK 40 oz. pressurised	£0.80
BODYSHELLS McLaren F1, Hesketh F1 with rear aerofoil	£2.50
Capri RS Saloon, Vauxhall Firenza Saloon	£2.60
Lola T294 Sports with rear aerofoil and fin plate	£2.90
BODY MOUNTING TRAY KITS	£1.35
Driver figure	£0.26
ACCESSORIES Engine silencer	£1.95
Engine heat sink (for extra cooling)	£1.25
Transfers (Giant size sheet, 84 sponsors decals + 35 numbers)	£1.25
Starter wheel (4 in. dia. hard rubber for electric starter)	£1.25

STOCK CAR SPARES

Silencer	£1.95
CHASSIS FRAME	£5.50
FRONT SUSPENSION Complete	£2.50
REAR SUSPENSION Radius arms	each £0.38
Radius arms spring	each £0.15
Radius arms attachment nut	each £0.10
Rear axle	each £0.40
½ in. Nyloc nut	£0.05
40t Drive pulley with tube pin	each £0.70
Drive belt	each £0.45
FLYWHEEL/CLUTCH UNIT Complete	£3.25
Clutch drum	each £0.80
FUEL TANK	each £0.45
WHEELS Front or rear	each £0.35
TYRES	each £0.55
BODYSHELLS Several types available (Std., Coupe, Chisholm, etc.)	each £1.70
RADIO CRATE with attachment screws	each £1.20

**BARCLAYCARD & ACCESS
WELCOME**

POSTAGE on MARDAVE KITS FREE
Decals 10p Parts 50p

Red Baron Models Ltd.

HAVE YOU TRIED OUR MAIL ORDER SERVICE

HOME AND OVERSEAS, POST PAID ON ORDERS OVER £25
UK ONLY. BARCLAYCARD AND ACCESS, TELEPHONE YOUR
NUMBER FOR IMMEDIATE DESPATCH ON THE SPOT. H.P.
TEN PER CENT DEPOSIT (S.A.E. WITH ALL ENQUIRIES)

HOBBYCARD

P.B. Racing Double R/C car	£28.93
P.B. Expert R/C car (comp.)	£56.21
P.B. Expert R/C car (std.)	£40.23
Mardave Stock Car	£21.50
Mardave formula 1 kit	£21.50
Mardave Capri or Firenza	£21.50
P.B. International	£75.00

FM RADIO IN STOCK
Multiplex FM 4 Function £213.28
Multiplex FM 7 Function £281.00

S/Hand Cars always in stock

HEAT SINKS, SILENCERS, FILTERS, TANKS, STARTERS, STARTER WHEELS, BODY SHELLS, MOTORS, RADIOS, TRAINS, BELTS, GEARS, CLUTCHES, TYRES, MOST SPARES IN STOCK.

497 HERTFORD ROAD, ENFIELD, MIDDLESEX

Late night Fri. 7 pm. Easy parking
Tel. 01-804 7452

MAKING A START

with

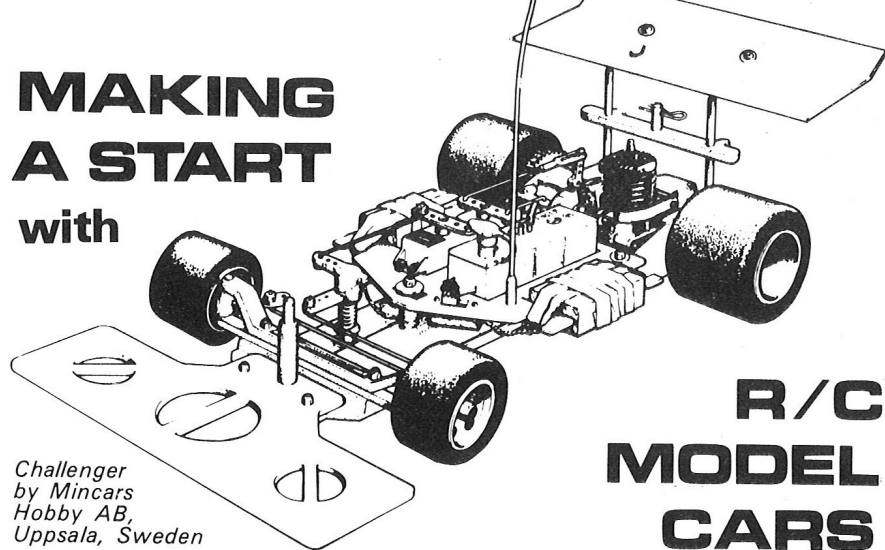

*Challenger
by Mincars
Hobby AB,
Uppsala, Sweden*

R/C MODEL CARS

WHAT IT'S ALL ABOUT

IT IS now possible for the average person — must be careful here, some of the girls are making a great show! — to build and run a radio controlled model car that will give troublefree performance and the opportunity of winning an occasional race; even sometimes surprising an expert and winning on handicap. There is no need to have any great technical skill or an elaborate workshop and tools just an urge to go out and race. In this way many people who might once have tried to storm their way into fullsize racing can enjoy all the thrills at a fraction of the cost and none of the danger.

There is a variety of kits from which to build, at prices and degrees of performance to suit all tastes; accessories are available in ever widening choice. Grand Prix, GT or simple saloon car racing is on tap; less demanding enthusiasts can settle for model Stock Car racing which is easy to set up, has limits on car cost, and has all the fun and most of the rules of the fullsize stockers. There are clubs in many parts of the country, a number of permanent race-tracks, many others set up on a temporary basis and a national association to organise fixtures and establish acceptable racing rules. This applies to most of the world, EFRA the European controlling body has fourteen member countries; U.S.A. has ROAR (Radio Operated Automobile Racing) and there are active groups in Australia, Canada, South Africa and South America,

TOOLS AND ACCESSORIES

The newcomer to the hobby and sport will probably already have most of the hand tools required either from earlier interest in model making or from the ordinary domestic and motor tool box. Assorted small spanners, power drill, files, vice, pliers in various sizes, adjustable and box spanners, hammer, electric soldering iron, screwdrivers make up the essential basis. A few taps and dies and a small lathe would of course be absolutely ideal but not essential.

Items that may need to be acquired are starting equipment for the i.c. glow-plug engine in the shape of a 12 volt accumulator and a starting device. This may be a hand starter, modified slightly from those used for model aircraft (such as Sullivan or Kavan). Alternatively a fullsize car starter acquired from a car dump for a trifling sum can be rigged up to do the job splendidly. Only snag is weight and bulk — but if you have an estate car or hatchback this is no special problem. A small 2 volt accumulator is also needed to supply current to the glow plug in the engine. Some people tap their starter battery to take off 2 volt but a separate accumulator is better (Varley do a very nice one). Charging of the 12 volt would be done on the trickle charger off the mains, most car owners now have one in the garage. A neat little charger can be obtained to charge the 2 volt in the same way. A glowplug lead and connector will also be required. Finally some form of quick pourer for

filling tank will be needed. But wait before getting this to see the type you fancy when you have seen other people in operation.

On the radio side you will need first of all a licence. This can be obtained from the Home Office, Radio Regulatory Department, Waterloo Bridge House, Waterloo Road, London S.E.1. This requires no test, lasts five years before renewal and costs £2.40 (U.K. only; other countries have their own similar arrangements). A radio transmitter and receiver plus a couple of servos with their appropriate batteries makes up the r/c parcel. Recharging equipment for the nicad batteries is also desirable. (Non-rechargeable batteries are right out of fashion these days). Since racing takes place against others using equipment at the same time crystal controlled equipment is a "must". This gives a choice of six main frequencies, differentiated by colour and the user displays a coloured pennant on his transmitter aerial to show crystals in use. Two are required for each outfit, one for receiver and one for transmitter. They plug in very simply and take only a moment to change. It is possible to get additional cars going with split crystals which operate on frequencies between the main six. The keen man will have a set plus at least one split.

At the moment Futaba equipment is the popular choice both on account of its extreme reliability and because they offer a particularly robust servo capable of being abused and overloaded madly. Other makers are, however, on the ball, and there is no reason for any of a number of other makes not to be used.

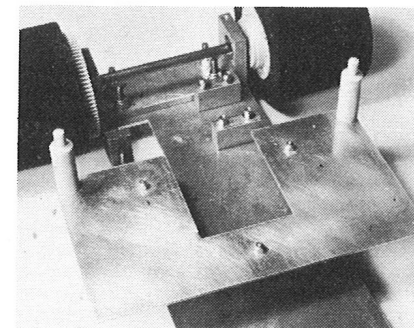

Simple radio plate, solid back axle fittings with ballbearings are features of GB KIT.

CHOICE OF A CAR

Cars are at the moment all of one eighth scale and come within certain specified sizes as set out elsewhere in this issue.

The variety of kits is quite astonishing, but basically they all provide more or less the same group of items: a chassis base, steering (which may be partly assembled or not), wheels, tyres, back axle, flywheel and clutch, a radio plate to carry the electrical equipment (or a plastic box to house it), brake, bumperplate, sundry links and connections. A body for Grand Prix or GT may or may not be included. Some provide a made up fuel tank in metal or plastic; others provide parts and instructions for assembly.

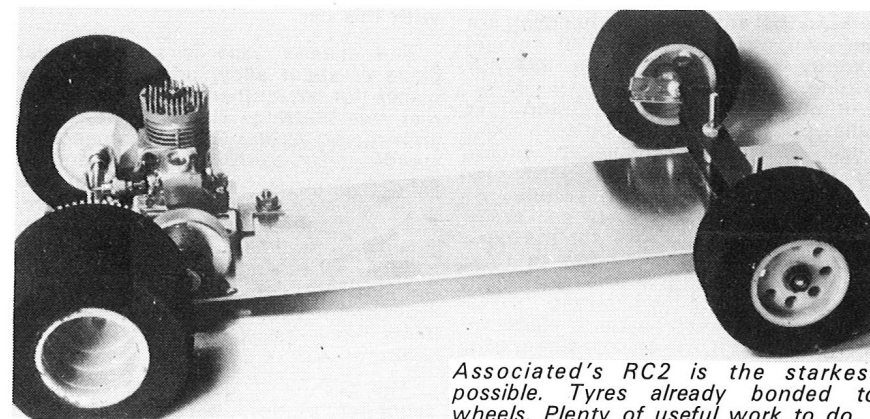

Associated's RC2 is the starkest, possible. Tyres already bonded to wheels. Plenty of useful work to do.

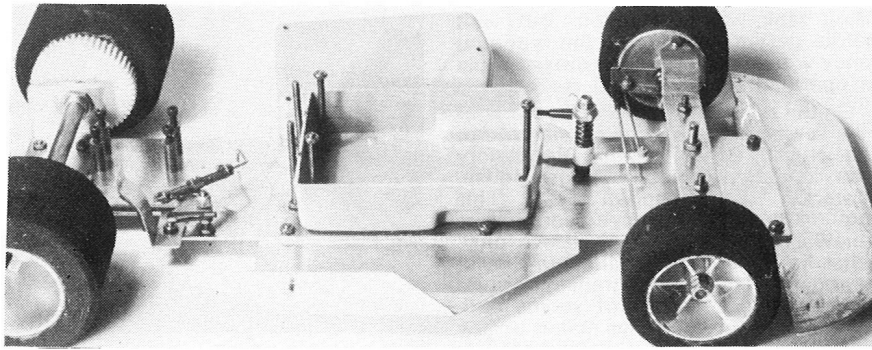

Mardave offer radio box, good accessories and long established reputation behind their popular kit.

The newcomer is strongly advised to choose a simple and fairly low priced (not necessarily the cheapest) kit and to get one that suits his style. That is if he/she is itching to get out on the track then the kit with the least work to do will be the choice. Others may like the delayed pleasure of a nice lot of making, including a fuel tank, and so get the feel of the car before actually running it. It should be said here that over the years very many ideas held until recently have been discarded, and the old adage of improvement by "adding a little simplicity" is being rigidly followed.

If you go to a meeting or two then the variety of possibles will be seen, and an opportunity perhaps turn up to buy a second-hand car that has already been running. You will save money this way and have the added satisfaction of knowing that constructionally it will work, so that any defects in handling are your own newcomer's lack of manual dexterity rather than faults in your building.

Although a great many Grand Prix bodies and GT bodies will be seen there is nothing like so much variety underneath them. Bodies can easily be switched from one car to another so that the chassis used for GP can easily be covered by a GT body for the next event. There is no objection to this. Strangely enough, the cars go better with GT bodies than with Grand Prix as time will indicate. A third class of Saloon cars seems to be something of a Cinderella of the race track — though again a standard chassis can be used with a fresh body.

GETTING TO WORK

Assuming that you have decided to make your car from scratch using a kit, and without too high hopes of an immediate world beater, we will try to lead you along using a couple of simple jobs as the instructions pieces. We have chosen first, a GB kit car which employs a certain number of parts from PB Products who make a series of cars from simple to sophisticated and in fact have just been scooping the National Finals meeting in a regular "white-wash". This car is a little up from the bottom with refinements such as ball bearings and a cast rear axle housing and one or two other goodies. The other "guinea pig" car is an American import by Associated, foremost U.S. manufacturer, their RC2 model, which is about the simplest and lowest priced of cars, being at the moment on "special offer". Another very modestly priced kit is the Mardave, which makes up very well, and is currently being assembled. Some of our pictures illustrate points with this car.

The chassis base is a rectangular piece of sheet alloy, drilled in sundry places for attachment of steering and rear axle housing. This is what comes with the RC2. The GB car comes with steering unit partly assembled and in place on chassis, as is the cast rear axle housing. Building instructions vary, from the barely adequate to the excellent. Sometimes one feels with the Italians, who we note now send out their kits with no instructions at all! A tribute perhaps to the legend that every Italian has a lathe and a workshop in his back garden!

The GB kit it will be noted has a secondary platform or radio plate added

to the base chassis. This enables the builder to locate his radio equipment at each side, outboard, and suspended on rubber bands to reduce the shock effects of engine vibration. Any motorcyclist knows that a single cylinder engine vibrates (as does a twin) and not until four cylinders is this overcome. Efforts to smooth out this vibration at engine level seem to make matters worse — solution is to protect the radio gear. Sight of some car racing will give the impression that the amount of dirt oil and road muck is another hazard, and surely it would be better to put the whole lot in one of the neat little plastic boxes also available. This is Mardave practice.

This is a fair point. However, in the stress and scurry of racing the problem of access arises. The plastic box has to be opened and takes non-available time, so that tendency is all towards slung radio equipment at top level. Slower racers who do not have racing crises may well prefer the box. Against this, if the engine is properly prepared, with adequate sealing of silencer attachment area, and fuel overflow is led back to spill off at the back, or to connect with silencer pot to assist in pressurising the fuel tank, then oily mess is negligible and only track dirt will come in. The air intake must also be protected against this road dirt, for, as we have heard it remarked "it acts like a miniature vacuum cleaner sucking in every unwanted thing in the district!"

Before we get too far along with the chassis put together a word on the objects to be desired. In earlier days there was a great deal of clever

springing incorporated, this has largely been discarded. What we require is a springy twisty front end which flexes and a rigid rear which does not. Hence the stout rear fitments to counteract the natural twist of the flat alloy sheet. Experts are now waiving the front end to provide even more flexion to that part. This brings up weight distribution as a factor. We want there to be plenty of weight at the back so that maximum wheel adhesion is obtained with somewhat less at the front, merely enough to provide steering. A balance point to give a 60/40% weight arrangement, or slightly more than we hope to get on the family car, is a good general allocation. This should not be too slavishly adopted at the expense of other mechanical factors.

For example, the shorter the connection link between servo and bell-crank, the more positive and less liable to failure it is. This has brought steering servos very much nearer the front than was formerly the case. A great deal can also be achieved in the varying hardness of tyres in providing the racing balance required. Harder at front, softer behind is the scheme, which helps to promote understeer, a desirable state of which more anon.

WHERE THE ENGINE GOES

You will not find engine mounting holes ready drilled for you in most cases, since the choice of engine is yours. Not, we must add, a very wide choice. Size

Wheels and tyres "as they come" before being bonded together. (These from GB kit).

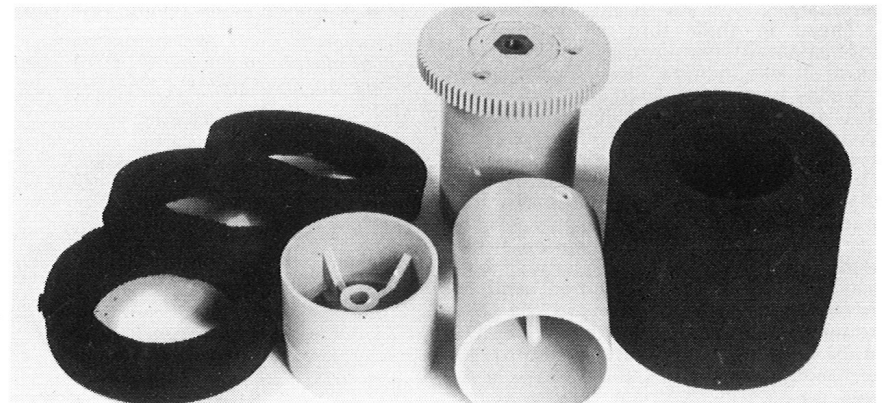

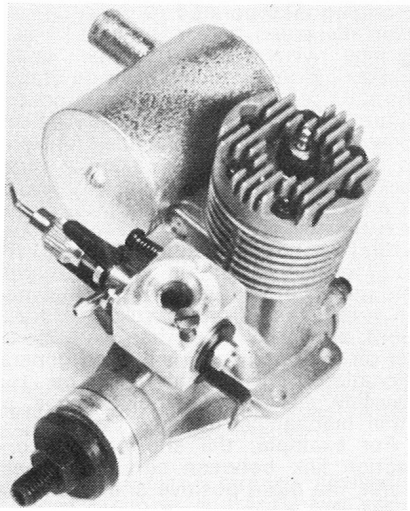

Ubiquitous Veco 19 with Kavan carburettor and Mardave silencer.

will be the limit set by the rules (and as large as can conveniently be handled in 1/8th scale we must add) of 3.5 c.c. or ranging from .19 to .21 c. ins. Most popular choice and ideal for beginners is the Veco 19, which is moderately priced, easy to operate and possessed of a good tickover which is essential, together with good low speed torque. Others in use include K & B., McCoy (usually now a hybrid of Veco and McCoy — the Vecoy) Super Tigre X21 (for the experts) and more recently the moderately priced Fuji which is Schnuerle ported, but as yet untried seriously.

These in their turn all require a sophisticated carburettor, and main types in use include Perry, Kavan and the slide type exemplified by the Thorp. But to return to engine mounting. Chassis will have a rectangular hole cut in it just forward of rear axle mounting. This is to allow the flywheel to protrude slightly below the chassis bottom for starting purposes. The spur gear which comes in front of the flywheel must be located to mate with the larger gear which goes on the rear wheel and is driven by the engine. Gear ratio will vary between four and five to one, or say 65 teeth to twelve to fifteen teeth. A common ratio will be about 4.25/1. A well tuned top class car may well be

running at 25,000 to 30,000 rpm and attaining *real* (i.e., NOT scale) speeds of up to 70 m.p.h.! But not while you're still a beginner please.

Set up the rear wheels, mount the flywheel and clutch on the engine and offer it to the larger spur gear for good mesh. Not a binding mesh but a neat approach. A good way to judge it is to put a couple of thicknesses of cigarette paper between the two gears — this gives just about the right amount of clearance. Mark carefully where this locates the engine. A friend with a helping hand is useful here.

With the RC2 kit two useful engine mounts are provided and have a slotted hole in each to allow for some slight forward/backward movement but not sideways. Engine is screwed onto these and two main holes popped and drilled out 3/16 in. dia. in the chassis plate, so that the flywheel comes evenly through the ready made hole with space all round and meshing nicely — it may therefore not necessarily be laterally central in the hole but with clearance.

FITTING THE CLUTCH

This is stepping back in assembly sequence and would be done before installing engine of chassis. Clutches vary in detail but are the same in principle. Two clutch shoes are each attached at a single point and can pivot on that point like a couple of railway signals. As the engine revs up these shoes are spun out by centrifugal force and come up against the round inner surface of a bellhousing which fits over them, and, taking a grip on this, spin the driving wheels. It is a constant matter of surprise to me that this actually works! It does, and is exactly the same as I was fitting to model cable racing cars some

Typical clutch components. Note stout springs on two shoes and clutch bell lining.

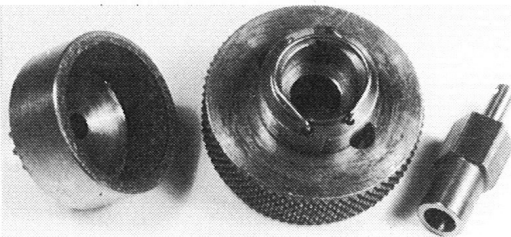

thirty years ago, so it has had quite a long testing time. The shoes are held in place by little springs which the speeding-up motor overcomes as the throttle is opened. The inside of the bellhousing is lined with similar material to that used for brake linings to give a suitable amount of bite and grip. Some shoes are of metal, others of such materials as tufnol. In some cases the holding-in springs are dispensed with and the shoes act without restraint. Until revs of the motor build up the car will idle without creeping forward on the ground. Adjusting the holding back springs will bring forward motion sooner or later as desired, but a degree of clutch slip makes for a more manageable car. **A word of warning!** Some of the parts for a clutch to be assembled (notably Associated's) are very small so put them together over a sheet of white paper, keeping bits not in use in an envelope or small tin. Alternatively, do as I did, and order a spare set of mini bits thus avoiding crawling over the floor looking for tiny dropped items.

UP TO THE FRONT

Now to get the steering end sorted. The GB car has its steering in place already and only needs to be touched up with a file to round off any rough edges that are sure to catch you sooner or later. Associated RC2 needs to be made up. Nearly all nuts are locknuts and need quite a bit of effort screwing home, so that a good box spanner or two is desirable. I usually put a head in the bench vice where layout makes this possible and screw up with the box spanner. The two long nuts holding steering wishbones will also double as

holding pieces for the body at a later stage in construction.

In the more expensive and sophisticated kits many parts here are moulded but with "cooking" kits the kingpin assemblies and pivot arms must be screwed up with the stub axles to make up into left and right hand units. Pivot arms may be pieces of twisted metal or angle with suitable holes drilled in them to take track rods later. Sometimes they will align the wheels straight ahead or may be bent to give an Akerman effect. That is to say if they were extended they should meet just ahead of the rear axle. Ideally, the inside wheel on a turn will describe a smaller circle than the outside wheel otherwise there must be a certain amount of scrub with the inner wheel doing less than its share of work. Some drivers will claim that since the inner wheel tends to lift on a corner anyway it does not really matter. However, the more expert will be delighted with the ingenious linkage recently developed by PB Products which does indeed give the proper theoretical response on a turn.

We are concerned with the more mundane toe-in. Wheels should be adjusted slightly "pigeon-toed" up to about 15 deg. in all, that is 7 1/2 deg. for each wheel. This improves steering and directional stability — full size drivers will also say it is hard on the tyres but this is an area where the model must exaggerate to obtain its effect. This adjustment is achieved by means of the track rod joining the two steering pivot arms. This track rod is a simple length of 16 swg piano wire, clipped into the holes provided either by bending up the wire

Steering detail on Mardave. Note fail-safe linkage and kink in track rod for fine adjustment of toe-in.

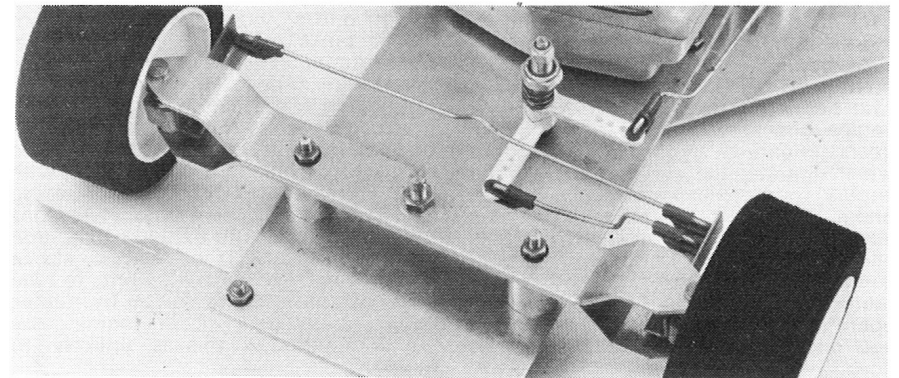

and fitting a washer over the end, or with special spring clips. It is usual to have one end of the track rod threaded to enable adjustments to be made quickly when testing. A little additional length to enable a V bend to be added to the track rod also provides this facility and is a form of servo saver.

This brings up the next little matter. If and when the car meets an obstacle it may be prevented by its bulk or location from completing the manoeuvre that has been signalled to it. The servo still goes on trying to do the necessary but in vain. It may overheat and be ruined in consequence. The servo saver or over-riding a form of spring loaded bellcrank takes care of this. Other devices are in use to achieve the same end. The American RC-2 has springs in little tubes which perform the same task. Once again PB Products have their own special gimmick which looks after this and provides excellent steering properties.

So far we have linked our wheels with a track rod and set up their toe-in. Another shorter length of piano wire is needed to come from the bellcrank/servo saver to one of the steering arms and connect via another of the holes drilled in it. It does not matter which side you attach, object is to have the shortest possible linkage from servo through to action station, wherever it may be. Once again we meet the option, whether to have servos tucked away neatly in a radio crate or out in the open as near the action as may be. This latter tactic is the one mostly followed though it means leaving the security of the radio plate and coming right up close to the steering.

STOP AND GO

With the chassis now beginning to look fuller and more like business we go back to the engine end. According to the kit in hand the rear axle may have plain bearings on angle brackets, be fitted with ball races and have a solid cast bearing plate. We have fitted our engine, checked the clutch and seen the gears engaging properly. The servo which operates the speed control on the engine, paradoxically also works the brake. When it is pushed in one direction it opens throttle, then comes back at midway point to engine tick-over, but on being pulled the other way brings a very simple brake into operation. So simple is it indeed that you may wonder if it really works. It does.

A half or less circle of curved sheet metal to which is stuck a layer of cork or rubber is pressed against the flywheel and rapidly checks forward motion. In some cases the lining is omitted and there is just the contact of brass sheet against iron flywheel. Since the clutch is centrifugal and only accepts the engine thrust at some fairly high rate of revs. this action is comparatively gentle but really does bring results. Just as at the steering end there was a servo saver, here again an over ride or spring loaded device is fitted, though probably not quite so essential here.

In one or two cases kits on offer have the brake drum as a separate item from the clutch, located on the back axle inboard from the axle bearings. This obviously relieves pressure on the flywheel that just conceivably might increase engine wear, but usually there is so much at that end of the car that space is not readily available. It is also possible to fit disc brakes, but this is stepping right into the experts' class and need not be considered at least for a few races.

Two things remain to be done engine wise. Connection between fuel tank and engine must be broken by the insertion of a fuel filter. This can be unscrewed and after a race or two the muck it catches will convince a doubting Thomas of its value. Similarly the air intake requires a filter for dirt can so easily be sucked in there. Foam devices are available and quite sophisticated honeycomb devices or a simple fine mesh gauze can be wired over. It must not be open meshed enough to let grit pass or so fine that not even enough air is let in.

TANKS

What sort of fuel tank should we be using? At the very bottom of the tree we can fit one of those simple translucent plastic tanks primarily used for model boat running. This offers a simple container with connection to a fuel line to the engine and a suitable opening with press on or screw top cap. Capacity will be something under the 4 oz. permitted racing size. There is nothing wrong with this, fitting should follow any building instructions given, so that location does not bring supply into a flooding position with the engine, that is not above carburettor level. Attachment to the chassis or radio plate will be by rubber bands to reduce risk of foaming by vibration, though this is unlikely to happen.

If we decide to be more ambitious we can follow the GB Models solution, which provides a shiny tin and lid (perhaps from the same place as the Coleman mustard tins come?) two short bits of metal tube, 1/4 and 1/2 in. dia. to be fitted, and a couple of longer lengths of thinner brass tube to provide feed and ventilation in the tank. You, the operator, will be expected to find a discarded metal tin lid off an empty 1/2-pint fuel can or similar to complete the metalwork. Final need is the fuel cap, which should permit easy no-time-at-all filling and yet hold in the fuel, in other words a "rat race" cap from the model aero world. Putting this together is a splendid exercise in soldering, even if in disgust you throw the whole thing away afterwards! I did! And started again to do it more elegantly. If you have not been soldering much recently you *do* tend to lose the knack, but it comes back, and an untidy job is an abomination.

The two things to remember in soldering are hot iron, repeat HOT IRON, and clean tinned surfaces. Then you cannot go wrong it is a matter of tidy manual dexterity with the tool, you do not need a lot of solder, a little in the right place is far far better. But do not despair; we will devote a whole article

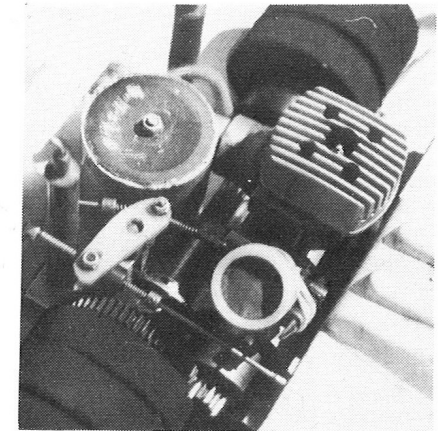

Dustbin silencer, "big head" heat sink, carburettor filter and springloaded servo saver linkage to disc brake.

soon to soldering. If you find it a bit too much at the moment, forget it, and acquire a ready-made metal tank. The tank we have just described is known as a "chicken hopper" tank enabling the last drop of fuel to be used, rather than slopping about in the bottom of a large flat area it all goes down into that little rescued tin lid. A completely made-up version can be obtained.

Other sophisticated tank versions are also on the market, including pres-

A similar set-up showing fuel tank with overflow leading back into dustbin silencer, ratrace type filler cap and radio gear elastic slung between pillars, which also serve to locate body.

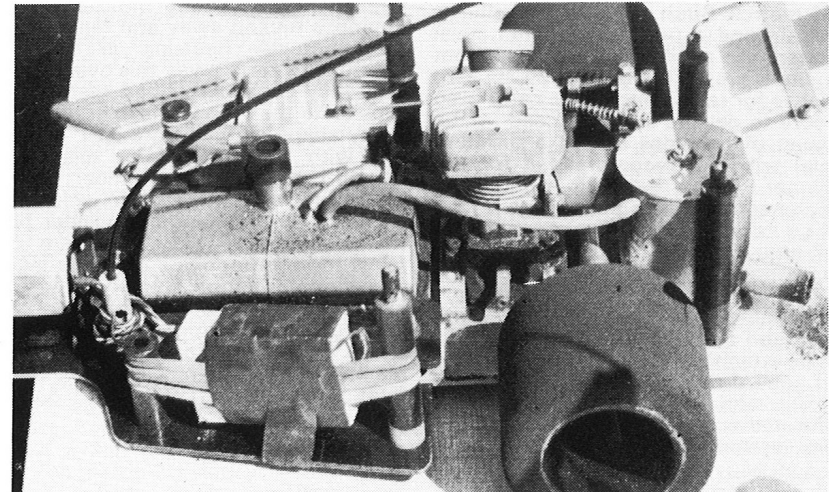

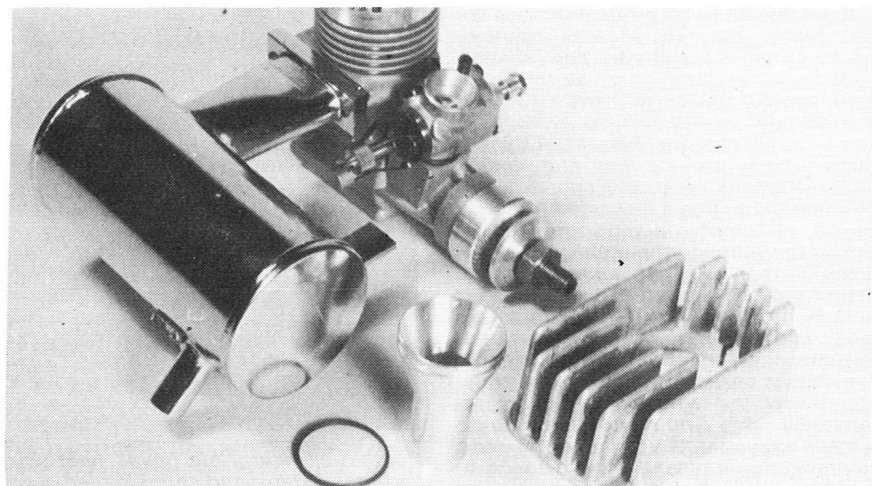

High class "goodies!" Super Tigre X21 packet showing heat sink, silencer and carburettor filter.

surised tanks where fuel line vent is lead back into silencer pot to increase pressure.

Whatever tank you decide upon connection to engine must be via fuel tubing, clear plastic tubing sold for the job. It will fit in a tight push fit over the tank lead out pipe and on to the engine fuel intake.

SILENCER

In these days of noise abatement, regulations good neighbour relations make good silencing of engines imperative. BRCA regulations require that noise level is kept to official limit of 80dB at 10 metres. Such a level is not difficult to attain and a number of commercial silencers are available. They vary from the small simple Mardave type (in two varieties for racing and stock cars — so be sure to get the sort you need — the exhaust pipe comes out at a different angle) which is recommended for the beginner. Being small it offers few attachment problems and whilst it may not be so efficient as the larger "dust-bin" type silencers this slight efficiency drop is not really to be deplored for the beginner.

Attachment method will vary with make (and even model) of engine. Veco can be attached via a dum-bell like fixing that goes through holes in the exhaust opening and then has a single screw fixing. Other Veco castings lack these holes, so that an all-round strap fitting is needed. Most other silencers are fitted with this sort of strap. The "dust-bin"

silencer usually sits upright on a small chassis extension at the rear, and has an additional metal fitting to clamp on to engine opening, the whole being joined with a short length of large diameter plastic tubing. There is also a large "dustbin" type that straps round like its smaller versions.

HEATSINK

Unlike model aircraft where the engine enjoys cooling breezes the car engine is tucked away and tends to get very hot. A heatsink is therefore essential to carry away this overheating. This may be a flat ribbed plate which slips on to the cylinder head or of a more fancy shape. Super Tigre X21 includes one with the engine, but this is not usual. Just recently a number of "big heads" have been on offer which take the place of the standard cylinder head for cooling purposes. These are certainly more attractive and it is indeed a "cosmetic" solution. However, the keen but impecunious builder can very well make up his own from scrap alloy. Take a look at those you can see and you will realise how simple they are to make at a fraction of the cost.

MYSTERIES OF TUNING

Author Fred Livesey is an engineering instructor at a government skill centre where emphasis rests on results not theory so is specially qualified to give practical tips.

FIRST LET me say that the title of this article probably sums up the average modellers attitude towards 'Tuning'. Then let me say that 'Mystery' and 'Magic' are not the secrets of a successfully tuned engine.

I believe that a well known racing engine designer has said that the success of his Formula 1 engine lies in the fact that he went back to basics.

Before we discuss the basics perhaps a few observations are required on highly developed engines. To win a race — you must finish — a fact that we all too often tend to forget. Reliability must therefore be our first consideration. Cars which finish only 8 laps (albeit in half the time of the others) don't take home laurels — I know from experience.

A further observation concerns the development of the full size racing two-stroke engines. Modifications which make a Suzuki or a Yamaha so much faster do not necessarily work on our small engines. Unless of course you find a way of making 1/8 scale fuel particles. Furthermore full-size engines usually use 10 speed gearboxes and rev. to 25,000 RPM — we use single speed and I believe ('though this may cause some controversy) rev. at 40,000 RPM. — under load. This fact probably accounts for the engine bearing casualties at the Nats. this year. Bearing manufacturers rev. limits on the sizes we use, with a riveted cage, are 25,000 RPM. HELP! First reliability problems which as yet cannot be overcome.

Back to the basics. There are distinct areas where improvements can be attained with time and patience.

The Time and patience are required to carry out the modifications and test, re-test, and even more testing to prove that there is in fact an improvement. The improvements can be considered under separate headings as follows:—

1. Reliability — the most important.
2. Mechanical efficiency — to reduce friction within the engine.
3. Volumetric efficiency — the filling of the cylinder with the maximum

quantity of fresh combustible mixture possible.

4. Combustion efficiency — the amount of potential heat available from the fuel mixture which is turned into actual heat.

5. Thermal efficiency — Amount of heat (from 4) converted into mechanical energy.

6. Increasing the number of power strokes per minute — i.e., RPM.

Most of the engines we use are mass produced with varying tolerances — hence the occasions when one engine straight from the box goes like hell, and yet another appears to be down on power. By carefully checking our engines we can get quite useful gains of power. This is known in full-size racing circles as 'Blueprinting'.

Before going on lets look at the equipment required:—

1. Electric drill on bench stand.
 2. Various lengths and diams. of wooden dowel.
 3. Degree disc and pointer. (Two protractors glued to white cardboard — fits on crankshaft. Pointer — piece 1/16 welding rod — fits on cylinder head screw).
 4. Shim steel — various.
 5. High speed grinding tool (Dremel Precision Petite or flexible shaft on drill).
 6. Various small grinding stones and burrs.
 7. Old pan for hot water, scrubbing brushes, soap and metal polish.
 8. Stop watch for testing.
 9. A luxury really — Testing dynamometer brake — saves time on testing.
- Let's now look at each section in turn.
- Reliability, as previously stated, must be our first priority when considering improvements. Whilst discussing each section any problems which could affect reliability will be pointed out.
- Mechanical efficiency, can be improved on all mass produced engines and one could say that it is 'something for nothing'. Friction is the main cause of reduced mechanical efficiency. Piston and con-rod mis-alignment, and

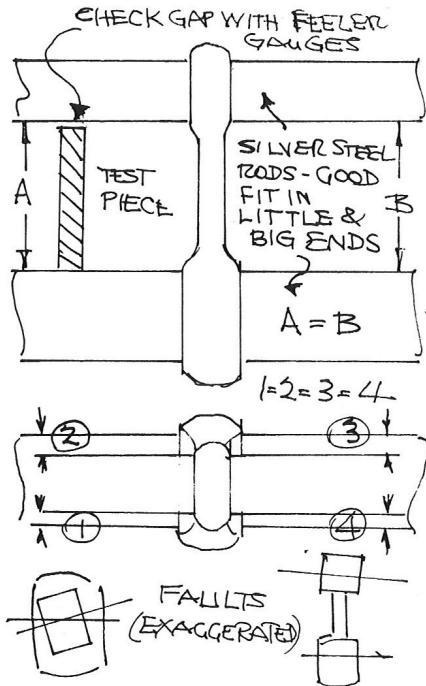

Fig. 1. Con rod alignment jig.

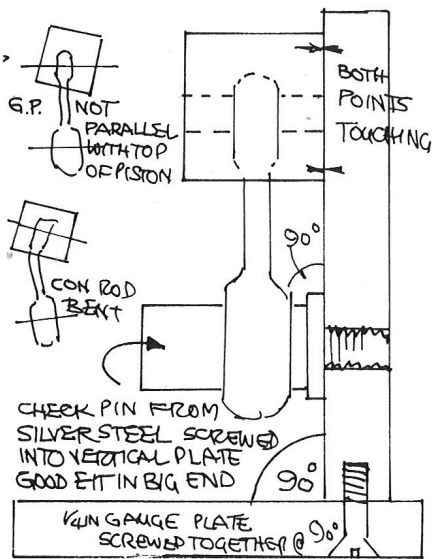

Fig. 2. Piston to gudgeon pin alignment.

incorrect piston to cylinder running clearances generate the greatest amounts of friction. Simple checking jigs can be constructed to check con-rod alignment (see fig. 1) and Piston and con-rod alignment (see fig. 2).

Piston to liner fit unfortunately can only be decided by experiment to strike a happy medium between good sealing and the minimum amount of friction. To check for fit immerse both parts in almost boiling water. The piston should feel stiff when pushed through cylinder without lubrication, but should slide easily when lubricated. The method I use to ease tight pistons is to lap piston to cylinder with metal polish up to a point $\frac{1}{8}$ in. from cylinder head face (see fig. 3). Thoroughly wash piston and liner in hot soapy water before each check. This gives excellent sealing on initial combustion and also relieves friction. Another method which has already been carried out by some engine manufacturers is to reduce the piston skirt diameter by .001 (see fig. 4). ($\frac{1}{2}$ thou each side).

This can be carried out by carving a piece of dowel to be a tight push fit up the inside of the piston and placing the dowel in an electric drill on a bench stand. By using 400 grade wet and dry abrasive paper with paraffin the piston skirt is easily relieved.

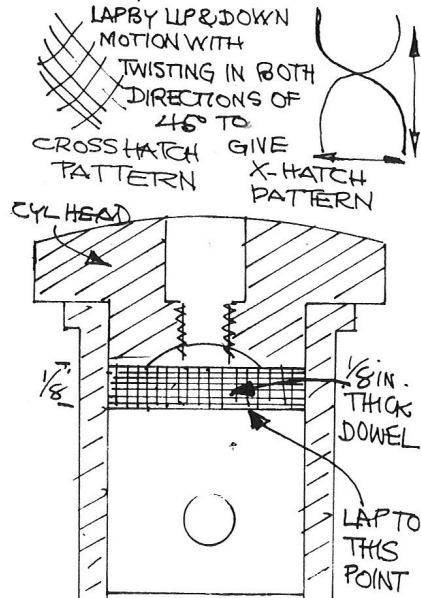

Fig. 3. Lapping piston to cylinder.

Another cause of friction which is often overlooked is that caused by distortion of the cylinder liner when hot. The distortion is caused by the port cut-outs and the uneven thickness of the outer cylinder casting. To relieve this distortion it is necessary to lightly lap the cylinder liner to cylinder casting with metal polish, after heating them both in almost boiling water until an easy push fit is achieved. This is slightly difficult but it can be done if a length of wooden dowel is inserted in the cylinder liner and the crank case is held in a gloved hand.

The fit of the big end bearing should not be too tight. A slightly perceptible amount of up and down movement is required.

Ball bearings in the engine should be checked for tightness or roughness. There should be at least .002 end float in the crankshaft to allow for crankcase expansion when hot (see fig. 5.) Use the aforementioned hot water method to check.

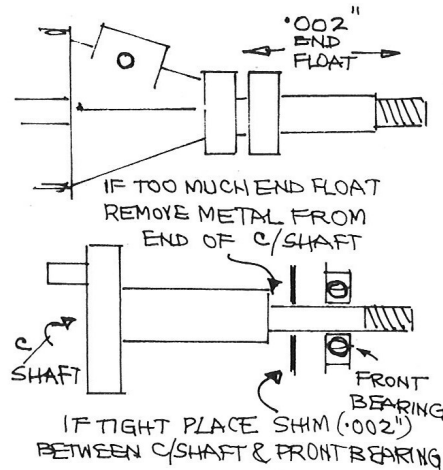

Fig. 5. Crankshaft end float.

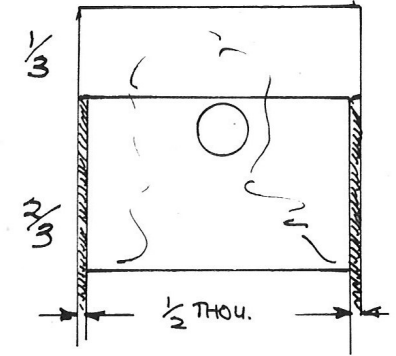

Fig. 4. Skirt relieving on piston.

This about wraps up the friction side of things and can alone give quite useful gains.

The volumetric efficiency — though sounding complicated is really quite simple. It is the greatest amount of fresh combustible charge with which the cylinder can be filled — or — the breathing of the engine.

The list of items which improve the breathing are:—

1. The length of the induction period.
2. The inlet, transfer and exhaust port areas.
3. The shape of transfer passages.
4. The crankcase capacity or pumping efficiency.
5. A minimum of restrictions in the exhaust.
6. The temperature of the incoming charge.

WOW! Plenty of areas for improvement when you think that each complete cycle or 2 revolutions of the engine takes only three thousandths of a second at 40,000 RPM.

SPEEDWAVE RADIO CONTROLLED CAR

Range up to 100 ft. Two Speeds

Our Price Only

£14.50

including VAT, post and packing insurance

Includes Transmitter and Receiver

Satisfaction Guaranteed
Trade enquiries welcome



EDRO TRADING CO.

7 New Moor Close, Southminster, Essex. CM0 7DL.

The carburettor bore is the first restriction which must be checked, but this must not be overdone or the bottom-end power of the engine may be reduced. A bore of 9/32in. seems to give a reasonable compromise. Again, this is a feature which only testing can really decide, by starting at 1/4 in. and testing with gradual increases until the conditions that provide good bottom-end power without any restrictions in top-end performance prevail.

The type of induction porting used by most of the engines in model cars is of the front induction variety. We have to modify the crankshaft to ensure that (a) the port is open long enough and (b) the passage is not obstructed.

In (a) only testing can show the modifications that are required. Before carrying out any modifications the timing of the crankshaft port should be checked with a degree disc and pointer.

Turn engine to top dead centre (TDC), adjust degree disc with pointer at zero. Check reading at bottom dead centre (BDC). Turning engine in the direction of rotation note reading as intake port opens after BDC. This should be in the 30deg to 40deg region. Continue turning engine, check at the point the inlet port closes — from 40deg to 60deg approximately — depending on the make of engine.

As previously stated the modifications necessary can only be done on a 'suck it and see' basis. First modifying the opening period by turning the degree disc so that the port opens 2 1/2 deg. earlier and marking the crankshaft with a scriber.

The crankshaft is then removed and the excess metal ground back to the line.

Then, by testing, an improvement should be noticed in the bottom end performance.

Tread warily — only 2 1/2 deg. steps. Metal can be removed but not replaced. A wise precaution is to have a spare crankshaft and record the results of the tests at the point where the performance is impaired. Go back 2 1/2 deg., and this is the port opening period which gives best results. A similar operation will have to be carried out on the closing point of the port.

This is where the patience comes in — but you can't get 'owt for nowt' at this stage of tuning. The port shape and crankshaft bore can be modified — (see fig. 6). Transfer passage shape should be as large as possible at the crankcase

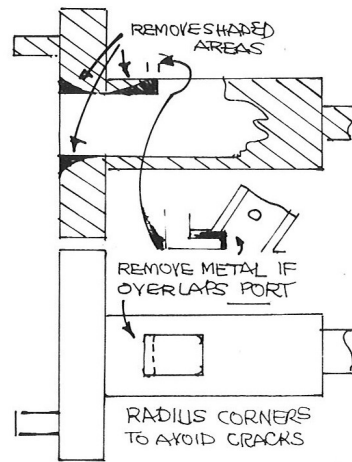

Fig. 6. Crankshaft Mods.

end, tapering to the same size as the ports in the cylinder liner with minimum steps and venturic shape (see fig. 7). Transfer and exhaust port timing can be increased in a similar manner to inlet port, but again, tread warily.

The crankcase capacity is one area in which improvements have yet to be tested. However, an interesting fact is that a reduction in capacity i.e., rear disc induction, only improves top end performance, and for our application we still need a reasonable bottom end performance. This has to do with the fact that if the speed of the transfer is increased, too much mixing of fresh charge with the exhaust gases takes place. This cannot be avoided altogether in the two stroke engine.

The exhaust system should be designed to avoid the above phenomena — and figures indicate that if the silencer is made ten times the cylinder capacity, the minimum amount of back pressure is present. Tuned pipes are of use only at one particular crankshaft speed and limit the power at other speeds. Ideal for planes and boats running at maximum revs, but not for model cars. I may be proved wrong in the future — but we'll see.

Temperature of incoming charge is an area where little has been done. As the mixture is heated it expands — crankcase cooling is a possibility here: Combustion efficiency depends on the fuel used, turbulence in, and temperature of the cylinder head — and glow plugs.

Fuel used is a mixture of methanol, nitromethane, and a lubricating oil. The

percentage of lubricating oil reduces the amount of combustible fuel in the charge, so the minimum amount of oil that can be used without affecting reliability increases combustion efficiency.

The nitromethane content has a direct bearing on combustion efficiency. Nitromethane is a fuel additive which is rich in oxygen when burned with methanol. The more oxygen available during combustion the better.

Percentages of nitromethane in the fuel mixture have been the cause of some controversy in the past, but the correct method is to increase the percentage slowly from about 15% until no noticeable increase in power is found. With a high nitro content the fuel tends to see off glow plugs rapidly (I heard a story of 20 plugs used at one meeting) — so beware! Also, nitro is now very expensive — and with 5% an improvement in tick over will be found.

Turbulence in the cylinder head is caused by the squish band area (see fig. 8). When discussing thermal efficiency we'll look at this. Temperature in the cylinder head should be around 80degC. I use the rule of thumb method of spitting in the head — if it sizzles it's about right — try various heat sinks.

Glow plugs vary between manufacturers, and even between the same type. Unfortunately this is one area we can do little other than find one type that with our particular engine gives maximum power and reliability.

Thermal efficiency is tied up with combustion efficiency in many ways. All the mixture in the combustion chamber must be burned to the best advantage.

The compression ratio of the engine has a direct bearing on thermal efficiency. With the fuel we use, very high compression ratios are possible. The only limiting factor at the moment is the glow plug elements. The difference between actual and swept volume compression ratios on our engines is the fact that the actual ratio is measured from the point the exhaust port closes. The swept volume is for the full 3.5cc capacity, i.e., full stroke. For ease of calculation we will use swept volume. The ratio needed is between 10-12 to 1 — again see which gives best performance.

The formula for checking compression ratio is:—

$$CR = \frac{\text{Swept volume of cylinder} + \text{volume of combustion chamber}}{\text{Volume of combustion chamber}}$$

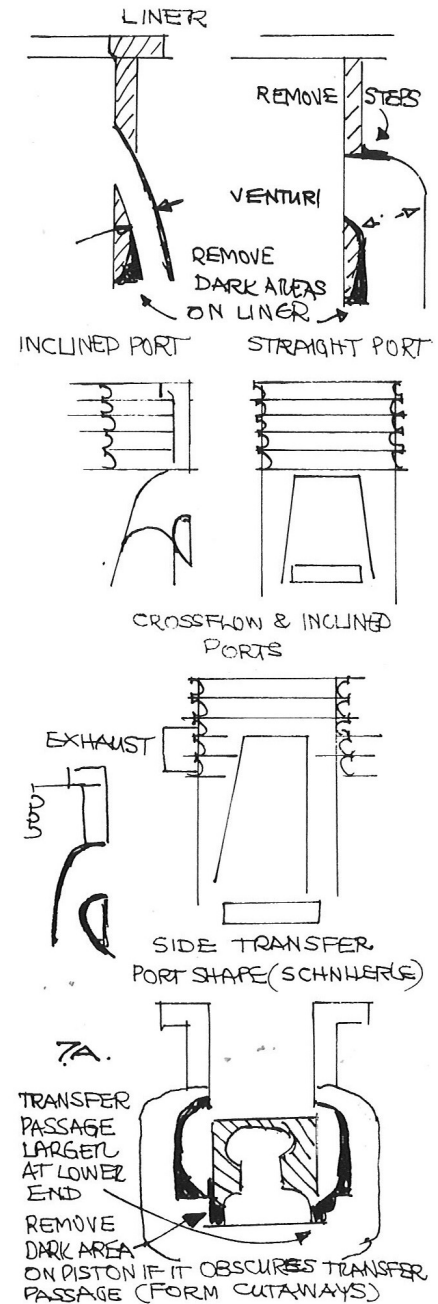

Fig. 7. Port and Transfer Passage Shapes.

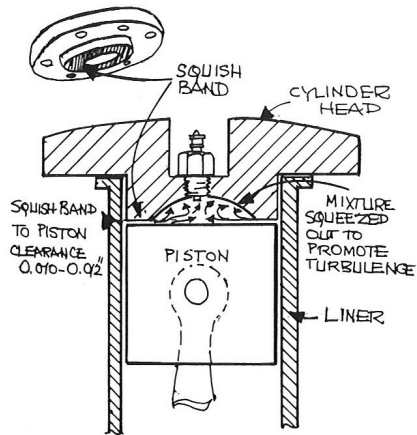

Fig. 8. Squish Band.

ELECTRIC CAR ELECTRONICS

By Richard Gammon

788 9711
 WITH THE emergence of the new electric car kits, glow-motor car drivers familiar with carburettor mixtures and the sound and feel of a well-tuned glow-motor, may feel that a mystique surrounds the way in which cold electricity from a battery produces torque at the wheels with no smell, certainly very little noise and only a moderate amount of heat.

POWER UNIT

The heart of the electric racing car is the battery pack and electric motor. We will take as an example the powerful and efficient power pack commonly being used with kits from Lectricar, conversions to Jerabee, etc.:-

(a) BATTERY: 6 x 1.2 amp hour nickel cadmium rechargeable cells (i.e., nominally, a 7.2 volt battery consisting of 1.2 volts per cell).

(b) MOTOR: type as Mabuchi RS54 (similar to MFA No. 205 and Ripmax Cyclone 15).

To understand what's going on inside the power pack, however, we first need to know "what" volts, "where" amps, and "what-sort-of" ohms.

You may remember from school days that:

(a) volts divided by ohms equals amps ($\frac{V}{R}=A$)

AND

(b) volts times amps equal watts (Horsepower) ($V \times A = W$)

These fundamental formulae, of course, do hold true as long as one knows exactly what is being measured.

BATTERY VOLTS AND AMPS

The modern miracle, the high-speed, dischargeable nickel cadmium battery, is inconsistent as follows: a battery with a nominal voltage of 7.2 volts, when on charge at 3 to 5 amps, will have 9 volts across its terminals when fully charged. This voltage must not be exceeded. On disconnection of charge, the terminal voltage will drop to around 8 volts — and you're ready for the race.

These can be checked by making plugs of plasticine in the shape of the swept cylinder and the combustion chamber. By using a measuring glass $\frac{1}{2}$ -full of water the amount displaced when the plasticine is immersed is the size of each. Using the above formula work out the compression ratio.

Turbulence aids thermal efficiency and improves combustion efficiency. The more turbulence — the smoother the flame travels during combustion, thus giving improved power flow. The squish band aids this turbulence. Clearance between the squish band and piston which appears to give best results is .010 in. to .012 in. (see fig. 8).

Glow plugs also have a bearing on thermal efficiency and the matters discussed in the previous section apply.

From the foregoing comments you can see that there are many areas which can effect improvements.

On discharge, the battery's 'internal impedance' (ohms) has an effect; so that if the motor were taking 10 amps, the actual battery voltage would be around 6 volts.

MOTOR OHMS

The electric motor, when stalled, has a resistance of fractions of an ohm, giving a stall current of maybe 20 amps.

Once the electric motor starts to rotate, effectively in series with the armature windings, there is a self-generated 'Back EMF' voltage. This voltage opposes the current flowing from the battery.

A permanent magnet motor, when revolving, can be regarded as partially acting as a dynamo generating this Back EMF. The faster the motor rotates, the greater the Back EMF, and the less current will flow through the motor. This is why the 'effective impedance' (ohms) of the motor varies in proportion to its speed.

MOTOR WATTS

At the instant of acceleration from stationary (without wheel spin), the motor could pull 20 amps from a battery loaded down to 5 volts; this would give a power consumption of (20 x 5), or 100 watts.

At maximum speed down the straight, the motor will be doing some 12,000 rpm's, and will only take approximately 3 amps with the battery now at 7 volts. Maintaining maximum speed will therefore consume (3 x 7), or 21 watts.

All the above figures are feasible statistics to illustrate the varying conditions.

The average current and wattage will be dependent on the acceleration of the vehicle. This is limited by the weight of the car, the gear ratios, wheel diameter, and the friction losses. At top speed, the addition of wind resistance will also have an effect.

MOTOR RESPONSE

The electric motor has the ability to absorb a lot of power at very low rpm's. This coupled with a far flatter power curve than a glow-motor, causes the electric car to exhibit a lot of torque at low speeds and gives instantaneous 'throttle response'. This is also aided by lack of flywheel inertia.

It is therefore important that any method controlling the speed of the motor be able to increase the power in a progressive manner.

SPEED CONTROL

The inexpensive systems supplied as standard by kit manufacturers are resistor current-limiting. That means, a variable resistance, consisting of:

- (a) 'rheostat' variable wire-wound resistor
- (b) resistive track printed circuit board resistor
- (c) switched fixed value wire wound resistors in series with the electric motor.

Although the above are good cost-effective methods, they have certain in-built disadvantages.

To appreciate the action of these systems, we need to know that in a series connection of resistor and electric motor:-

(a) The current flowing is the same through all components.

(b) The input battery voltage is split up and shared across the resistor (ohms) and motor impedance (ohms) in proportion to their ohmic value.

AND

(c) Motor speed is controlled by the voltage across it.

Because of the above rules, the relationship between the transmitter stick position and car speed is not what it should be. We can now follow through the effect of varying the controlled resistor's value.

CONTROL(?) BY RESISTOR

By reducing the value of the control resistor, we make more current flow through the motor, which then accelerates. Having achieved higher rpm's, the motor impedance is now higher; and it therefore now takes a bigger voltage share. This causes an 'overshoot' effect. Also, the motor impedance is very much affected by its loading at any one time.

The reverse happens when throttling back as the motor impedance reduces as the motor slows down.

So in attempting to control the speed of the car by regulating the volts across the motor, we are varying one value of ohms in series with another ohmic value which won't stay still! The effect is to give a 'rubbery' relationship between stick position and car speed. There is also some hysteresis, so that stick position to speed will vary depending on whether one is speeding up or slowing down.

One other problem obviously occurs with switched resistors: one cannot smoothly increase or decrease the speed of the motor.

Variable resistors are especially vulnerable when nearly at full power with maximum load at low speeds, for they need to pass maximum current of 15 to 20 amps.

WASTED WATTS

As the battery is a high percentage of the car's weight, it is essential for maximum performance that all the electrical 'fuel' is transferred efficiently to the motor.

It is quite obvious that for a series resistor to reduce the voltage across the motor, it must dissipate the 'difference' voltage times the current flowing through both resistor and motor.

The resulting 'lost' watts are borne witness to by the enormous amount of heat that the resistors generate. That power **should** be conserved for turning the wheels.

TRANSISTOR ASSISTED RESISTOR

One answer to some of these problems is to use a power transistor as a variable resistor. A lower power variable resistor feeds a controlling current into the base of the transistor, and the collector-emitter control the current to the motor. In this analogue mode, the power transistor still dissipates and wastes all the power the big resistors would.

ELECTRONIC MOTOR SPEED CONTROLLERS

The electronic answer is to control the average voltage across the motor terminals. This is achieved with a high degree of efficiency, and excellent range and progressiveness of control by a 'power chopper' system. The full battery voltage is applied to the motor at any speed, but this voltage is switched on and off at a high rate. The period of 'on to off' ratio is varied so the motor sees an average voltage which forces the motor speed to follow the 'mark-space' ratio very closely.

The principles involved in a good system owe something to:-

- (a) Modern T.V. Switch Mode Power Supplies.
- (b) Class 'D' power amplifiers
- (c) (and even something to the old R.C.'ers) Galloping Ghost

The switching speed is so fast that the motor simply emits a quiet audio frequency tone.

GOOD CONTROL

Very narrow pulses give extremely slow speeds and allow delicate increases in torque when drifting around corners. At any selected speed, the motor sees a 'low impedance' supply; this means the controller has greater authority to change motor speed, regardless of original speed or varying loads.

CONTROLLABLE BRAKING

Unlike resistor control systems where braking is achieved by loading the Back EMF voltage with one fixed resistor, it is a simple matter electronically to arrange proportional braking. By applying the same variable mark-space principle described to a power transistor shorting-out the motor, adjustable braking is made possible: the transmitter stick will then give full power, back to 'neutral', and then back to full braking. This system is very like the carburettor-braking arrangements on glow-motor installations.

POWER SAVING

Due to the inherent efficiency of the modern power transistor switching systems, at partial throttle settings, power not used by the motor remains in the battery for use later in the race. As proof of the pudding, it will be noted that a good speed controller runs very cool — and there are no wire wound resistors using up valuable watts and creating a fire hazard!

INSTALLATION

The installation of a sophisticated electronic speed controller is very simple: the pulse information lead plugs directly into the receiver, and there are 4 wires to convey the power from the battery and thence to the motor. There is, of course, no need for a servo and linkages in this lightweight installation.

A much-simplified servo-operated switch arrangement may be retained in order to give the luxury of reverse. A double-pole changeover switch is inserted between the controller and the motor.

Trusting that you now have a better feeling for the way electric cars work, it must be emphasised that electric car racing is very clean and painless to get into. In a short period of time, very many people have bought car kits and started racing quite happily with little or no knowledge of what's going on under the bonnet. This information is presented in order to increase the fund of knowledge we all accumulate relating to our expanding and challenging hobby. By the same token, what do you have to do to the front tyres now the rear ones are 10% wider and higher . . . ?

BRITISH NATS AT LILFORD PARK

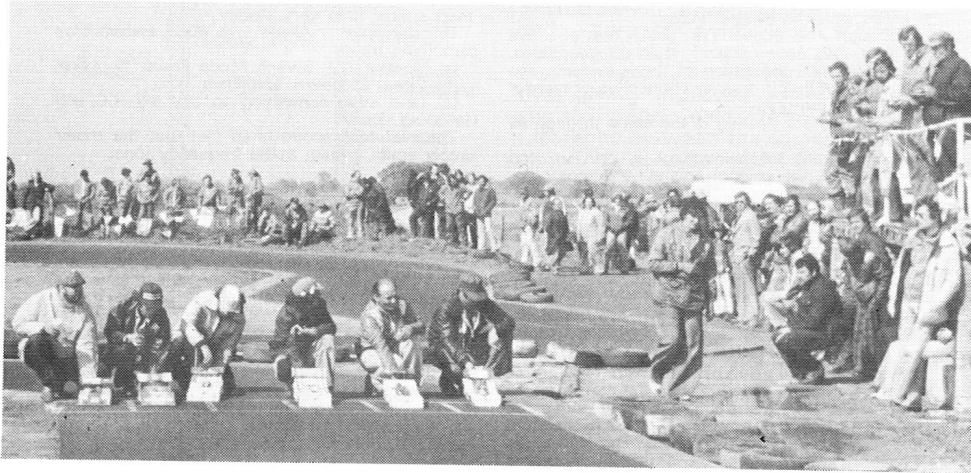

Mechanics hold cars at the ready for a Sports/GT heat at Lilford Park . . . weather uncertain.

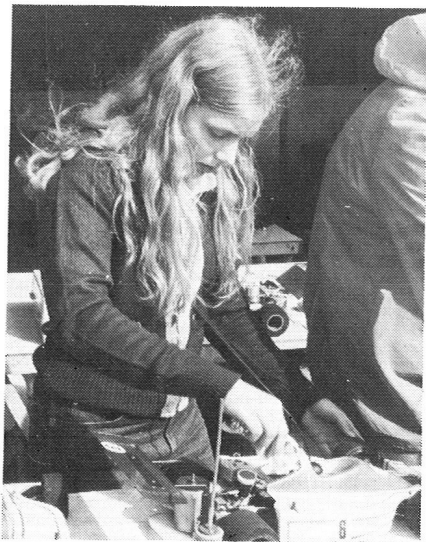

Debbie Preston cleans up No. 6 on GP day.

IN SPITE of horrible weather, which at one time had young Mark Plested operating a mini-skidpan on the concrete outside the pits a good time was had by all; there was a good turnout of entrants; and a fair attendance of spectators — hoped for converts to the cause. In what was virtually a PB International "whitewash" some notable figures were prominent.

It became very much a game of Dads versus the children. Dads being Keith Plested, Dave Preston and the Kids being Mark Plested and Dave Martin plus Debbie Preston, who must be about the cleanest tidiest mechanic I have ever seen, yet manages to wind up a car with the best of them. Nor must we forget another Dad — Tom Martin doing a very powerful stint in the judges/timekeepers trailer. Tom of course reporting these events is somewhat inhibited by being father to a winning son, so I can say what he must be thinking that it is pretty marvellous for an eighteen year old young man taking his A-levels prior to going up to

Tom Martin, Dad, works on the score sheets whilst Dave Martin, Son, relaxes with Coca Cola and thinks up the next ploy.

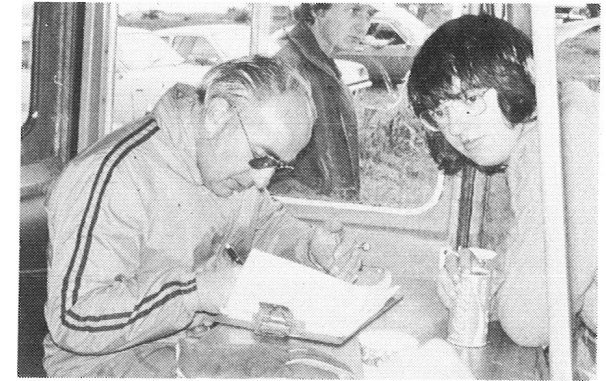

Oxford to do physics to be third in Formula, 1st in Sports/G.T. and 1st in Saloon. Well done Dave.

There is a lot of luck in every race, and results would have been different perhaps if Phil Booth had not been going so fast and bent an axle; if Phil Greeno's housing had not worked loose. These two were indeed going very very fast, but to win you must finish in front. Keith Plested proved the best of the Dads with a triple second — nearly there in every event. Dave Preston (ex fullsize Lotus Elite racing I believe) was a worthy winner of the Formula event. Any day now I expect the chips to fall right and Debbie Preston to sport the laurels. She made two finals with an excellent third place in Sports/GT. It

was something of a minor disappointment to see the bad luck which pursued Ted Longshaw — anything that could fall off or split seemed to do just that, and for the first time for a long time, he played only a modest part in the latter stages of the meeting.

We have mentioned a "whitewash" for PB Internationals which does not mean they were all the same. What with the choice of two chassis, and the personal preferences of drivers they all had separate characters; some waiving them severely amidst others going for full width chassis. Super Tigre X21 was in good showing, sported by the Prestons, Pat Ellis and Phil Booth. Martin, Plesteds and Greeno were running K & B, suitably breathed upon

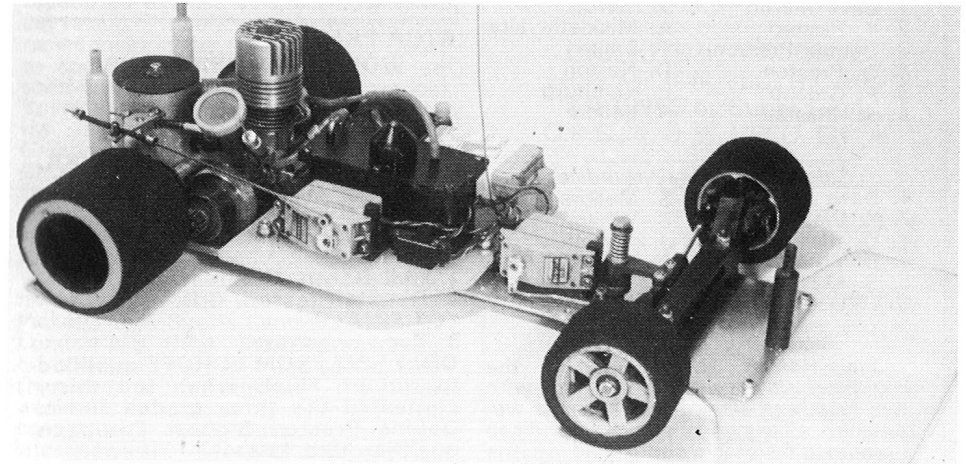

The racing hero in person — PB International uncovered and typical of its breed.

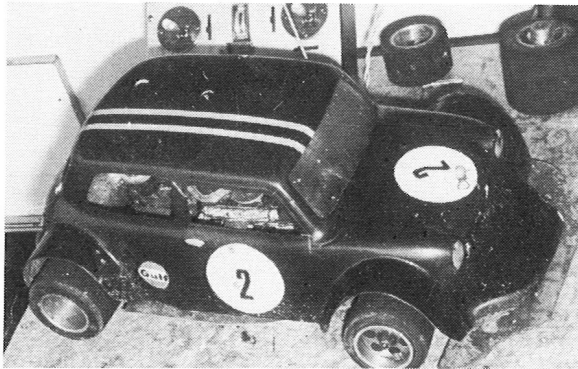

Most amusing car at the Nats. Fred Livesey's Mini, which went well though not amongst the winners.

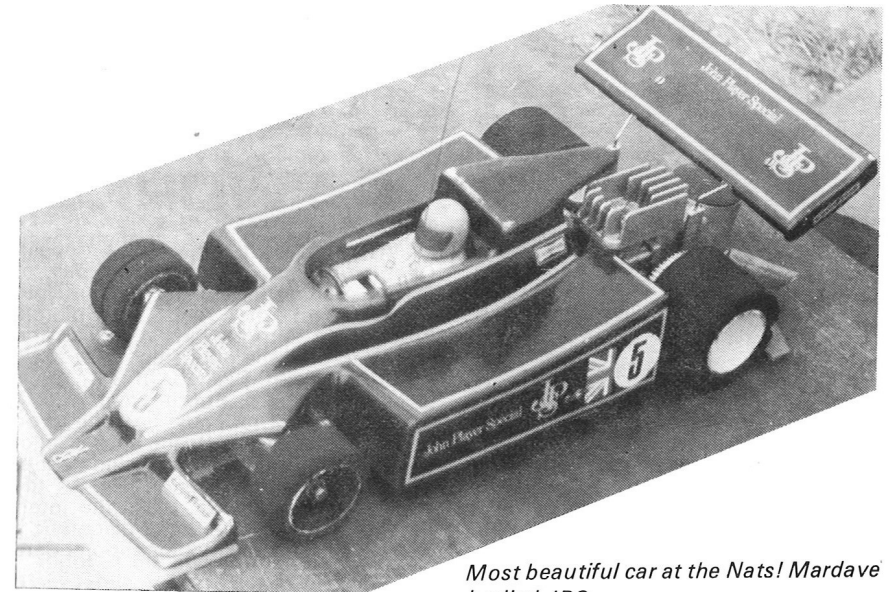

Most beautiful car at the Nats! Mardave bodied JPS.

in some cases, I though claimed to be running absolutely standard cars.

Tyres in use were divided amongst Associated moulded for the front or PB with Delta 340A or 2402 or PB at the back. There is still a lot to be said about tyres. We hope we can get round to finding a suitable soothsayer soon.

Here are the placings:

Formula	Handicap
1. Dave Preston	J. Harrop
2. K. Plested	P. Pagdin
3. D. Martin	P. Bligh
4. R. Ellis	T. Booker
5. Debbie Preston	L. Hamburg
6. P. Booth	T. Longshaw

Sports/GT	Handicap
1. Dave Martin	J. Harrop
2. K. Plested	A. Micklethwaite
3. Debbie Preston	T. Smith
4. D. Preston	D. Norton
5. P. Greeno	L. Hamburg
6. M. Plested	R. Lemin

Saloon	Handicap
1. Dave Martin	S. Mellors
2. K. Plested	S. White
3. D. Blair	J. Harrop
4. K. Wheldon	R. Lemin
5. S. Mellors	D. Blomfield
6. Plested	P. Bligh

Jim Harrop shows up in the Handicap placings extremely well with two firsts and a third. His Formula win put him nine laps ahead on handicap running off scratch and ahead on the circuit. The Sports/GT Handicap event, probably one of the closest yet, had

all six cars in at the end and virtually on the same lap! Jim again! He could only manage a third in the Saloon Handicap with a few engine troubles. We hope we can persuade him to write up his special own-design crankshaft in due course.

All of this effort also produced the seven drivers who go to the European championships at Lyons. Formula and Sports/GT produced the same qualifying heads so that team is: D. Martin, D. Preston, P. Booth, D. Rogers, Debbie Preston, K. Plested and Ted Longshaw (Paul Mason with equal placing conceded to Ted). Whether all the points chasing was worth it no one is quite sure: very much the same team would be going on a straight selection committee choice, but then perhaps justice would not be seen to be done!

STOP PRESS
WORLD CHAMPIONSHIPS
RESULTS
from Pomona, California

"A" FINALS (The Tops)
1. Butch Kroells, Associated USA.
2. Bill Janus, Associated, USA.
3. Gene Husting, Associated, USA. to 7th place Associated.

"B" FINALS
1. Phil Booth, G.B.
3. Debbie Preston, G.B.

"C" FINALS
3. Ted Longshaw.
ONLY FIVE FROM EUROPE qualified to run on Finals when top thirty contested the three graded finals. Debbie Preston highest European qualifier 13th fastest.

NEXT ISSUE: Phil Greeno, our man on the spot, report in full.

"ALLY PALLY" ELECTRICS
NEED NEW HOME!

CAN ANYONE offer us a home? The enthusiastic Alexandra Palace R/C Electric Car Racers are seeking a temporary address for their growing membership. Born three months ago thanks to the efforts of organisers Dave Rogers and Brian Field (of Red Baron fame), the rapidly expanding club ranks reflect the explosive impact of electric car racing. Twice a month, some thirty racers meet in the Palace's Palm Court to compete in heats that lead up to semi-finals and the final event. Lectricar, Bolink and Jerobee appear to dominate the track. Top drivers include Phil Greeno (recently running at the World Champs in California) Robin Ellis, and Dave Rogers. But the Palace roof must undergo extensive repairs very soon and racing must take elsewhere for about three months.

Temporary residence during this homeless period will probably be Picketts Lock Sports Centre, Edmonton London N.9. Other possibilities will be considered. Ally-Pally electric enthusiasm is contagious... all are welcome to join us as spectators or competitors. Ring Dave Rogers for latest news at 01-804-0928 or Brian Field at Red Baron Models (01-804-7452) — Wendy Bork.

MICHAEL'S MODELS
646-648 HIGH ROAD
N. FINCHLEY N12 0NL
Telephone 01-445-6531

CAR KITS by MARDAVE
P. B. KE'JON, LECTRICAR
ENGINES by Super Tigre
O.P.S., K. & B., VECO, ENYA

STOCK CARS

KE'JON	£29.95
MARDAVE	£21.50
SLIDE CARB FITS	
K. & B. 21	£14.00
P. B. INTERNATIONAL KIT	£75.00

PHONE YOUR CREDIT CARD NUMBER
FOR SAME DAY SERVICE
ACCESS BARCLAYCARD CARTE BLEU
EUROCARD MASTERCARD VISA
BANK AMERICA CARD



Keith Plested with one of the two cars he took to California (this one I think is young Mark's).



Too pretty a pattern to miss! Bits and bobs for Australia destined Racing Double kits.

WHAT GOES ON AT PB WORKS

LONG AGO — at last year's European Championships — that clever pair of Franco Sabbattini and his Super Tigre friend down the road at Bologna produced a surprise packet of car and engine to beat the opposition. Not to be outdone, Keith Plested of PB, Dave Preston and Phil Booth went into a huddle to see what could be done to go at least one better. Result was a pilot run of PB Internationals and about Easter time the production run. As the top kit of the Experts' Class the International not only merits its place but it has swept the British competition board all this season.

Which is why any contest report is inextricably mixed up with the PB Products Works at Havant which we invited ourselves to visit when we renewed acquaintance with Keith at Lilford Park Easter Meeting and first saw the car. As a small hobby outlet one might expect a cottage industry type of works, but not a bit of it! Here is a well established model trade manufacturer still turning out hundreds of balloon wheels for model aircraft every week — some wholesalers would look very silly if the supply stopped — and packing and exporting something like seventy per cent of the r/c car output. We did just mention Queen's Award — but frankly no one really has the time to do the form filling.

There are some surprises too at Havant, notably a young man putting out hundreds of metal pressings plus other oddments we hardly recognised. "Oh, yes," says Keith "that's the old Racing Double, the Australians simply can't get enough of them" and before we left there were another couple of hundred Racing Doubles (remember it? of course you do, and affectionately!) getting packed up for the Antipodes.

A lot of changes too are in hand. Flywheels were formerly produced by a series of operations that went right down the line, making perhaps a hundred a week. Introduction of an automatic, skilfully set up by Keith, and a

young man versed in the art, has actually made stock in hand with 350 beautifully finished in the bins in less than a full working week. Other operations are giving the management to think. For instance the clever front axle assembly demands a number of separate operations, including taking metal off all four sides before drilling can commence on a special jig (that took several weeks to make, by the way). Basic shape could of course be drawn, but minimum order for two tons of metal would stock up the works for years to come with some two million units! Next thought is to start diecasting at Havant instead of putting this sort of work out — always a fingerbiting worry — and here again the works skill comes in. Virtually every piece of equipment has been readied in the works. That is to say, some second-hand machines are bought, sometimes in an awful state, but sound deep down, and rebuilt with sundry alterations to do the jobs for which they were acquired.

Right at the end of the factory is the Black Hole where tyres are cut and bonded together and trued up. The rubber dust is horrible, gets in everything, including the lathe, which is wrapped up like a mummy with cellophane and tape. Tyres of course are the most wasteful thing made, with sixty per cent non-recycleable bits since they are stamped from the sheet like making mince pies. A better practical answer will be found to be sure.

It is a jolly factory with everyone interested in the work and the things they make. Keith has a bit of a yard at the back for a practice track, and the long drive at the side of the sheds is just long enough to get up full chat — his drag strip. When we were there all thoughts were towards the Californian trip and two cars had to be prepared.

We have hardly touched on some of the work in hand. The splendid miller which produces the caliper for the disc brake shoes. Such a lot of metal seems to be shaved off, but they come off steadily, one every few minutes. A small automatic plastics injection moulding machine takes care of a lot of bits and pieces. It can be left to itself most of the time to get on with whatever it is processed to be doing. Then there is a battery of assorted drills that finish off that kingpin cum steering arm unit.

This then is the background to the PB International. We shall be talking a great more about it in future issues.

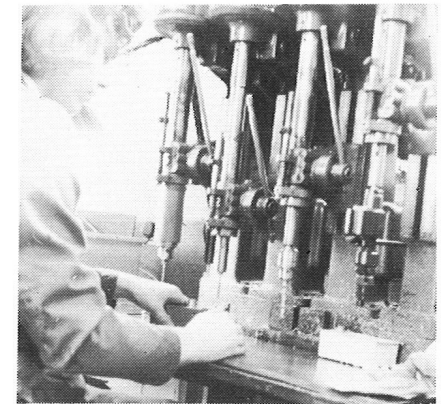

Battery of drills, mills and reamers to work on front axle assemblies via jig in operator's hand.

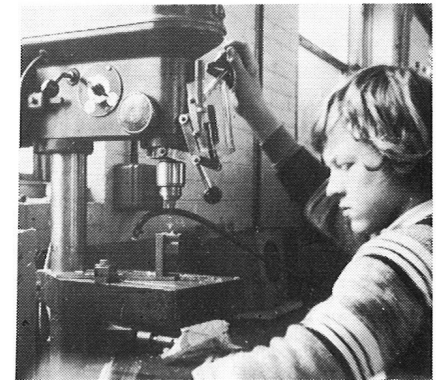

Just one more hole in the production scheme!

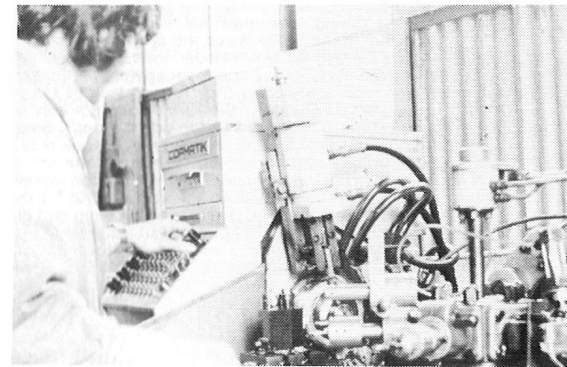

Now on the automatic! Making flywheels looks so easy this way.

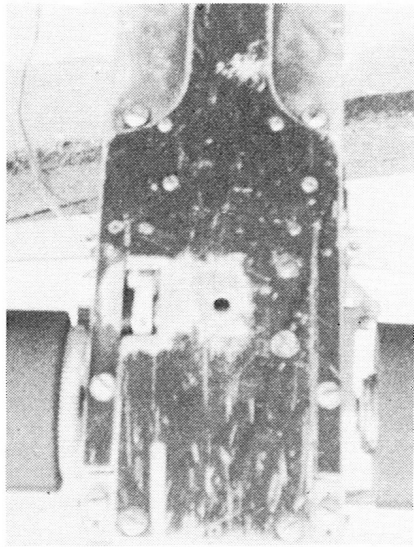

"SPRING HEELS"

Dick Winder talks about his springheeled chassis that won so convincingly at Catfoss

The design of the car itself is basically a simple extension of the common flexy-chassis principle, rear leaf springs and two trailing arms providing a firm, positive rear suspension whilst retaining chassis flex towards the front end. The chassis plate is stamped from high aircraft alloy, heat treated to reduce surface stressing. Long slots in each side of the trailing edge of the chassis plate separate the springs which are an internal part of the chassis, which is waisted in the middle to give excessive flex which is then damped by a 'Lexan' plate, the front bolt-hole of which is elongated to allow movement and bolted through, with an asbestos washer providing the friction medium.

The main problem besetting the design of a car with rear suspension is that of achieving suspension travel, without sacrificing gear mesh at the extremities of deflection. The only positive way to surmount this is to ensure that the rear axle performs a perfect arc around the centre point of the drive pinion, in the best motorcycle practice. Hence the ¼ in. tool steel rear axle, shod with P.B. wheels runs in ¼ in. x ¼ in. ball races through the two trailing arms, one of which pivots on a ball-race behind the flywheel in the crankshaft itself, the other being located on a specially fabricated crank-case backplate.

The front end is largely courtesy of P.B. although the axle-blocks are our own with centre point steering and geometry to create the theoretical Ackermann angle. This can be roughly obtained by projecting a line rearward from the kingpins through the track-rod end bush with the steering in the straight ahead position. The lines should cross in the centre of the rear axle, though, if a split track-rod is used, the positioning of the steering crank can affect this. Although this method is rather rough and ready the results are quite effective, with a reduction in tyre scrubbing allowing faster, smoother cornering. True Ackermann steering is not necessarily perfect as this does not allow for slip angles of tyres; it assumes that the tyre follows a perfect arc with no slip sideways. At this point you leave me and go talk to Robin Herd, or maybe Derek Gardner since he has to work it out on twice as many wheels as anyone else.

Back to our car, the front wheels are not ball-raced but ran on plain shafts as do the P.B. Experts. The axles are high tensile socket head shoulder screws, the shoulder being ground to such a finish that the wheels spin very freely without any perceptible play on the axle.

Having driven the car now for a few months, competing in half-a-dozen race meetings, has given me a chance to assess its capabilities. On a bumpy circuit the car has a distinct advantage. Not only can it hold a constant radius around a bend over quite rough surfaces without deviation, but the steering is also very responsive. On a smooth surface, it possibly slides at a lower speed than a solid, giving the driver a chance to correct the slide as it starts.

There are two points which highlight the handleability of the chassis, one; that a saloon car body does not upset the balance of the car and, two; that a relative novice can keep the car on the track in race conditions. I think it is this unique feature of the car that won me my first two pots.

IT IS only recently that I have become involved in model car racing as a competitor. Throughout 1976 I noted increasing numbers of my customers taking of turning to model cars and a trial stock of a few kits and accessories confirmed them as the main growth area in R/C modelling. As a long-time motor-racing fan myself, I took to the cars all the more readily and, by the autumn, listening to the exploits of others was like watching my brother sink a pint while I had to stay dry.

My first attempt at building a car was to modify a PB Dual to incorporate some of my own ideas but owing to my inexperience of preparation, the car never stayed together long enough to find out how successful my modifications were. Lesson 1 If you foray into a new field start off by sticking to established principles. If you're a budding engineer there is plenty of time to try your ideas one by one after you've learned to drive.

Phase two came though the local club, which I joined, home base being the Catfoss circuit. I had noted during the previous season, interested remarks in the press about the suspension chassis raced by two of our founder members, Ken and Les Wheldon. Some performances were particularly auspicious considering their relative lack of funds. (Ken claims to have run the 1976 season not only on one engine, but just one piston ring to boot). Since they are such nice co-operative types, it took only a little bribery and corruption to acquire one set of parts to construct a replica of their car for myself. Three weeks later I was on the starting grid for the Easter Lilford meeting. Diving in at the deep end did not produce immediate success but experience was invaluable. After a wet meeting at Bradford, the sun shone for Catfoss, and, on the home circuit, I was still somewhat surprised to take home the trophies for the F.1 and G.T. handicaps against some very top line opposition, the latter being won on the road as well as on handicap. This result owes very little to my driving ability (strictly limited as yet), but a great deal to the superb handling of the chassis on a bumpy circuit. My standard Super-Tigre also performed admirably on relatively low-nitro fuel.

rj. models

SPECIAL FIRST ISSUE OFFER

First 15 orders for MARDAVE KITS

£20.00 post free

Pay by cheque or cash but ring first to reserve your kit.

PLUS

1 PB Expert Junior

£32.50

1 PB Expert Standard

£40.50

JACKSON ELECTRONICS NEW FIELD CHARGERS

Ideal for 2-day meetings, charge from car battery. Input 12 v. D.C., output 50 mah. L.E.D. charging indicators.

NC 1 single £3.50
 NC 2 single with terminals £3.60
 NC 3 dual simultaneous £3.95
 MAINS CHARGER
 NC 4, 50 mah £4.95
 GLO-CONVERTER runs Glo-plug from car battery £5.95
 NC 5

RADIO BODIES TYRES per pair

Rear 2 ½ in. wide 3 in. O.D. (3 ¼ in. O.D.)

per pair
 Hard £2.40 (£2.45)
 Med/hard £2.75 (£2.80)
 Med/soft £1.80 (£1.85)
 Soft £1.80 (£1.85)

Front 1 ¼ in. wide 2 ¾ in. O.D. (3 in.)

Hard £1.10 (£1.20)
 Med/hard £1.30 (£1.40)
 Med/soft £0.90 (£0.95)
 Soft £0.90 (£0.95)

Also RJ Models specials

1 ½ in. wide x 2 ½ in. O.D.

SECOND-HAND

Mardave Capri with Super-Tigre X-19 clean car £30.00

Special, PB rear end, Hewitt front beam, Veco 19 £25.00

Special, Mardave running gear in braced 6mm Lexan chassis, with almost-new Super-Tigre X-21 £42.50

Delta, ex-Dave Rodgers, ex-Ray Metcalfe, full-house K & B £80.00

Stocks include a selection of new and used motors, Mardave and PB spares, etc. Send 2 x 9P stamps for catalogue.

WATCH THIS SPACE

Our new suspension car will be ready shortly. See article elsewhere in this issue. Prospects for the kit are looking good as we go to press, with nuts, bolts and peculiar shaped lumps of alloy in a hundred little boxes. Price should be around £65.00; conversion kit for PB Expert roughly half that.

RJ Models
 340 Holderness Road
 Hull
 North Humberside.
 Tel. (0482) 23491

MAIL ORDER by
 cheque, P.O., C.O.D.
 Barclaycard or
 Access

THE DRIVING FORCE FOR R/C CARS

VECO 19 SM

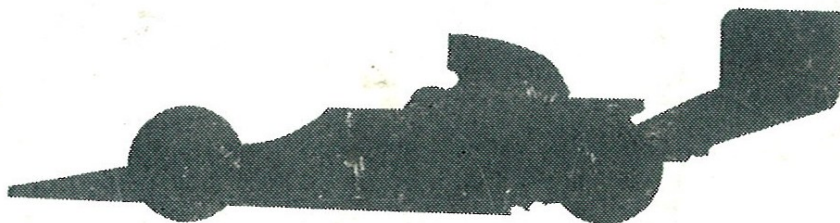

This competitively priced .19 engine incorporates a robust crankshaft which is supported by two precision ballbearings for a long working life fitted with the renowned Perry carburettor for superb throttling

£22.75

VECOY HIGH PERFORMANCE CONVERSION PARTS

Improve the performance of your Veco 19 engine with these special tuned components.

STAGE I CONVERSION (Liner and Piston)

Specially tuned conversion kit incorporating ringed piston and high performance liner

£23.50

STAGE II CONVERSION (Liner and Piston)

A more advanced form of tuning is utilised to ensure maximum performance and long life

£28.50

Two special crankshafts are also available for further improvement in performance.

Available through your local Model Shop!

IRVINE ENGINES

Unit 8 Alston Works Alston Road

HIGH BARNET HERTS 01-440-0923